

TEKNİK ÜRÜNLER

FİYAT LİSTESİ

2020/1



İÇİNDEKİLER:

ISITMA - SIIHI TESİSAT VALFLERİ

Elektronik Termostatik Radyatör Valfleri (E-TRV)	3
Termostatik Radyatör Valfleri	5
Termostatik Radyatör Valfleri (Krom)	6
Termostatik Radyatör Valfleri (Pex Boru Bağlantılı)	7
Termostatik Radyatör Valfleri (Kompakt Tip Panel Radyatörler İçin)	8
Termostatik Radyatör Valfleri (Debi İç Ayar Tertibatlı)	10
Termostatik Radyatör Valfleri (Kafa Grupları)	11
Termostatik Radyatör Valfleri (Çift Akış Yönlü)	12
Termostatik Radyatör Valfi (Yatay Eksenli)	14
Termostatik Radyatör Valfleri (H-Tip)	15
Radyatör Valfleri	17
Krom Radyatör Valfleri (Havlupan Tipi Radyatörler İçin)	20
Radyatör Geri Dönüş Valfleri	22
H-Valfler	24
Rakorlar	25
Pex Boru Bağlantı Elemanları	26
Döşemeden Dağıtım Sistemleri	27
Kolektör Bağlantı Elemanları	29
Otomatik Havalandırıcı ve Purjörler	30
Emniyet Valfleri	32
Su Tesiştir/Kombi Emniyet Valfi	32
Doğalgaz Küresel Valfler	33
Kilitlemeli Doğalgaz Küresel Valfler	34
İçme Suyu Küresel Valfleri	35
Endüstriyel Tip Küresel Valfler	36
Özel Amaçlı Küresel Valfler	38
Mini Küresel Valfler	39
Hortum Uçlu Mini Küresel Valfler	40

Şiber Valfler	41
Şiber Valfler, Optimize Tip	41
Stop Valfler	42
Kosva Valfler	42
Filtreler ve Çekvalfler	43
Flatörler	45
Su Basıncı Düşürücü Valfler	46
Musluklar	48

DÖŞEMEDEN ISITMA SİSTEMLERİ

Döşemeden Isıtma Debimetreli Kolektör Seti	52
Döşemeden Isıtma Debimetrelessiz Kolektör Seti	53
Döşemeden Isıtma Alyan Anahtarlı Kolektör Seti	54
Termal Kontrol Vana Motoru (Aktüatör)	55
2-Yollu 1" Termal Kontrol Vanası	55
Ana Kontrol Ünitesi	55
Oda Termostatı	56
Akıllı Oda Termostatı	56
Kolektör Askı Seti (Döşemeden Isıtma)	56
Hava/Su Boşaltma Seti	57
1" Rakorlu Küresel Valf	57
1" Termokupl Çıkışlı Rakorlu Küresel Valf	57
Pex Bağlantı Rakor Grubu	57

YANGIN SİSTEMLERİ

Sprinkler	59
Yangın Vanaları	61
Test ve Drenaj Vanası	62
Küresel Valfler (Hortum Uçlu)	62

E-TRV sizi anlar!

Siz yaklaşınca evinizi ısıtmaya başlar, evinizden uzaklaşınca ısıtmayı kapatır.

E.C.A. E-TRV tercih ettiğiniz oda sıcaklığına göre radyatörünüzü ayarlar, odayı hep aynı sıcaklıkta tutar. Böylece odalarınız arası sıcaklık farklarının da oluşmasını engeller. Üstelik, akıllı telefonunuzdan da yönetebilir ve E-TRV'nin tüm akıllı özelliklerini kullanabilirsiniz.



- E-TRV internete bağlanarak, mobil cihazınız üzerinden tüm özellikleri kontrol edilebilir veya E-TRV termostat başlığından sıcaklık değeri manuel ayarlanabilir.
 - E-TRV, günlük 15'er dakikalık zaman dilimlerinde 7/24 programlanabilir, konforu ve tasarrufu en üst seviyeye çıkarır.
 - 250 metre veya 25 km mesafe aralığında evinize yaklaştığınızda, siz gelmeden evinizi ısıtmaya başlar.
 - 6 Adet E-TRV internet köprüsü ile eşleştirilerek, mobil cihaz ile odalar birbirinden bağımsız olarak ayarlanabilir.
 - Uzun pil ömrü ile 2 yıldan fazla kullanım imkanı sağlar.

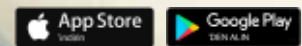

*Sadece E.C.A. İnternet Köprüsü ile çalışır.



ELEKTRONİK TERMOSTATİK RADYATÖR VALFLERİ (E-TRV) Maksimum Enerji Tasarrufu ve Konfor

ÜRÜN	ÜRÜN KODU	ÜRÜN ADI	TEKNİK ÇİZİM	LİSTE FİYATI ₺	ÜRÜN KT. AD.
	602 120 966	İnternet Köprüsü + E-TRV + R1/2" F Gövde Köşe		1.725	2
	602 120 969	İnternet Köprüsü + E-TRV + R1/2" F Gövde Düz Başlangıç Kiti Gövde • M30x1,5 - R1/2" F Elektronik Termostatik Radyatör Vanası • Beslenme Gerilimi: 2 x AA pil (kutuya dahil) • Bağlantı: M30x1,5 İnternet Köprüsü • Beslenme Gerilimi: 100-240VAC • Eşleştirilebilir Cihaz Sayısı: 6 E-TRV • Kutu İçeriği: 230V Kablo, Çift taraflı bant ve vida poşeti		1.730	2
	602 120 967	İnternet Köprüsü + E-TRV + Bağlantı Aparatları (RA/RAV/RAVL) Başlangıç Kiti Bağlantı Aparatları • 3 Adaptör (RA/RAV/RAVL) Elektronik Termostatik Radyatör Vanası • Beslenme Gerilimi: 2 x AA pil (kutuya dahil) • Bağlantı: M30x1,5 İnternet Köprüsü • Beslenme Gerilimi: 100-240VAC • Eşleştirilebilir Cihaz Sayısı: 6 E-TRV • Kutu İçeriği: 230V Kablo, Çift taraflı bant ve vida poşeti		1.675	2
	602 120 963	E-TRV + R1/2" F Gövde Köşe			880
602 120 964	E-TRV + R1/2" F Gövde Düz Gövde • M30x1,5 - R1/2" F Elektronik Termostatik Radyatör Vanası • Beslenme Gerilimi: 2 x AA pil (kutuya dahil) • Bağlantı: M30x1,5 *Sadece E.C.A. İnternet Köprüsü ile Çalışır	885	6		
	602 499 423	E-TRV + Bağlantı Aparatları (RA/RAV/RAVL) Bağlantı Aparatları • 3 Adaptör (RA/RAV/RAVL) Elektronik Termostatik Radyatör Vanası • Beslenme Gerilimi: 2 x AA pil (kutuya dahil) • Bağlantı: M30x1,5 *Sadece E.C.A. İnternet Köprüsü ile Çalışır		830	6

• Fiyatlara KDV ayrıca dahil edilir. Tavsiye edilen bayi satış fiyatıdır.
SİRKÜLER NO: S2020101

%30 'A VARAN ENERJİ TASARRUFU

**TÜRKİYE'NİN İLK VE TEK
I. SINIF ENERJİ
VERİMLİLİĞİNE UYGUN
YERLİ ÜRETİM
TERMOSTATİK RADYATÖR VANASI!**

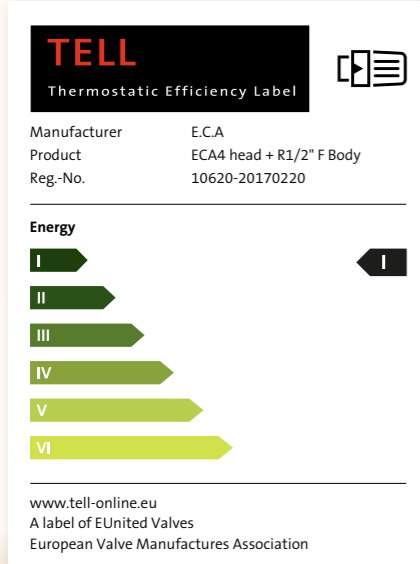



- * E.C.A. termostatik radyatör vanaları, normal radyatör vanalarına göre %30'a varan enerji tasarrufu sağlar.
- ** E.C.A.2 ve E.C.A.4 kafa grubuna sahip termostatik radyatör valflerimiz EUnited Valves tarafından TELL ürün sınıflandırma kapsamında I. sınıf enerji verimliliği seviyesinde onaylanmıştır.
- *** E.C.A. termostatik radyatör valfleri bir sezonda kendisini amorti eder.

TERMOSTATİK RADYATÖR VALFLERİ
EN 215, TS EN 215, %30'a varan Enerji Tasarrufu

ÜRÜN	ÜRÜN KODU	ÜRÜN ADI	TEKNİK ÇİZİM	LİSTE FİYATI ₺	ÜRÜN KT. AD.
	602 120 755	1/2" TERMOSTATİK RADYATÖR VALFİ KÖŞE TRV4 • 15°C Ortam Sıcaklığı Alt Limitli		85	22
	602 120 756	1/2" TERMOSTATİK RADYATÖR VALFİ DÜZ TRV4 • 15°C Ortam Sıcaklığı Alt Limitli		85	22
	602 120 531	1/2" TERMOSTATİK RADYATÖR VALFİ KÖŞE TRV3 • 15°C Ortam Sıcaklığı Alt Limitli		81	22
	602 120 532	1/2" TERMOSTATİK RADYATÖR VALFİ DÜZ TRV3 • 15°C Ortam Sıcaklığı Alt Limitli		81	22



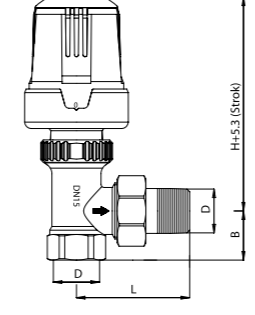

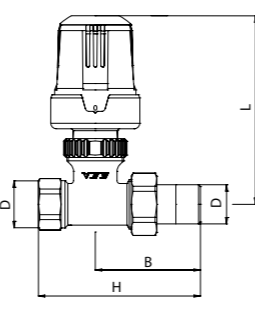

TERMOSTATİK RADYATÖR VALFLERİ (Krom)

EN 215, TS EN 215, %30'a varan Enerji Tasarrufu

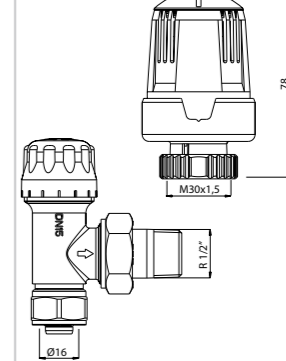
ÜRÜN	ÜRÜN KODU	ÜRÜN ADI	TEKNİK ÇİZİM	LİSTE FİYATI ₺	ÜRÜN KT. AD.														
	602 120 162	1/2" TERMOSTATİK RADYATÖR VALFİ KÖŞE Krom - TRV		141	7														
	602 120 181	3/4" TERMOSTATİK RADYATÖR VALFİ KÖŞE Krom - TRV		162	7														
		<table border="1"> <thead> <tr> <th>Ürün Kodu</th> <th>D</th> <th>L</th> <th>B</th> <th>H</th> </tr> </thead> <tbody> <tr> <td>602 120 162</td> <td>R 1/2"</td> <td>53</td> <td>23</td> <td>100.2</td> </tr> <tr> <td>602 120 181</td> <td>R 3/4"</td> <td>53</td> <td>26</td> <td>100.2</td> </tr> </tbody> </table>	Ürün Kodu	D	L	B	H	602 120 162	R 1/2"	53	23	100.2	602 120 181	R 3/4"	53	26	100.2		
Ürün Kodu	D	L	B	H															
602 120 162	R 1/2"	53	23	100.2															
602 120 181	R 3/4"	53	26	100.2															
	602 120 164	1/2" TERMOSTATİK RADYATÖR VALFİ DÜZ Krom - TRV		141	7														
	602 120 183	3/4" TERMOSTATİK RADYATÖR VALFİ DÜZ Krom - TRV		162	7														
		<table border="1"> <thead> <tr> <th>Kod No</th> <th>D</th> <th>L</th> <th>B</th> <th>H</th> </tr> </thead> <tbody> <tr> <td>602 120 164</td> <td>R 1/2"</td> <td>82</td> <td>50</td> <td>50</td> </tr> <tr> <td>602 120 183</td> <td>R 3/4"</td> <td>98</td> <td>65</td> <td>65</td> </tr> </tbody> </table>	Kod No	D	L	B	H	602 120 164	R 1/2"	82	50	50	602 120 183	R 3/4"	98	65	65		
Kod No	D	L	B	H															
602 120 164	R 1/2"	82	50	50															
602 120 183	R 3/4"	98	65	65															

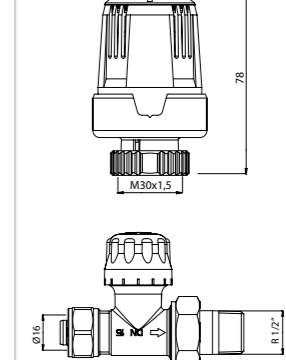
TERMOSTATİK RADYATÖR VALFLERİ (Pex Boru Bağlantılı)

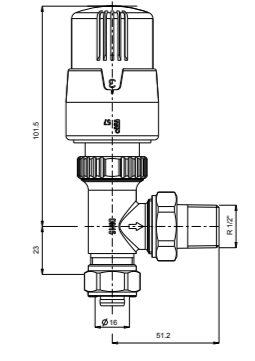
EN 215, TS EN 215, %30'a varan Enerji Tasarrufu

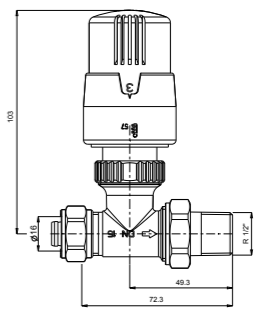
ÜRÜN	ÜRÜN KODU	ÜRÜN ADI	TEKNİK ÇİZİM	LİSTE FİYATI ₺	ÜRÜN KT. AD.
	602 120 549	TERMOSTATİK RADYATÖR VALFİ, KÖŞE (Ø 16 X 2 mm) - Pex TRV3 • 15°C Ortam Sıcaklığı Alt Limitli		88	22
	602 120 548	TERMOSTATİK RADYATÖR VALFİ, DÜZ (Ø 16 X 2 mm) - Pex TRV3 • 15°C Ortam Sıcaklığı Alt Limitli		88	22
	602 120 780	TERMOSTATİK RADYATÖR VALFİ, KÖŞE (Ø 16 X 2 mm) - Pex TRV4 • 15°C Ortam Sıcaklığı Alt Limitli		93	22
	602 120 779	TERMOSTATİK RADYATÖR VALFİ, DÜZ (Ø 16 X 2 mm) - Pex TRV4 • 15°C Ortam Sıcaklığı Alt Limitli		93	22

TERMOSTATİK RADYATÖR VALFLERİ (Kompakt Tip Panel Radyatörler İçin)







EN 215, TS EN 215, %30'a varan Enerji Tasarrufu

ÜRÜN	ÜRÜN KODU	ÜRÜN ADI	TEKNİK ÇİZİM	LİSTE FİYATI ₺	ÜRÜN KT. AD.
	602 120 325	TERMOSTATİK KOMPAKT RADYATÖR VALFİ TRV2 kafa+ iç kompakt ventil		115	7
		<ul style="list-style-type: none"> Dıştan contalı, uzun tip (44 mm) Debi içi ayarlı valfi ile birlikte 			
	602 120 326	TERMOSTATİK KOMPAKT RADYATÖR VALFİ Krom kafa - TRV + iç kompakt ventil		125	7
		<ul style="list-style-type: none"> Dıştan contalı, uzun tip (44 mm) Debi içi ayarlı valfi ile birlikte 			
	602 120 540	TERMOSTATİK KOMPAKT RADYATÖR VALFİ TRV3 kafa+ iç kompakt ventil		76	7
		<ul style="list-style-type: none"> Alından basmalı, kısa tip (35 mm) Debi içi ayarlı valfi ile birlikte 15°C Ortam Sıcaklığı Alt Limitli 			
	602 120 541	TERMOSTATİK KOMPAKT RADYATÖR VALFİ TRV3 kafa+ iç kompakt ventil		76	7
		<ul style="list-style-type: none"> Dıştan contalı, uzun tip (44 mm) Debi içi ayarlı valfi ile birlikte 15°C Ortam Sıcaklığı Alt Limitli 			

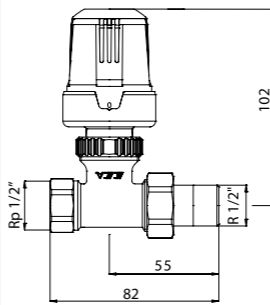
ÜRÜN	ÜRÜN KODU	ÜRÜN ADI	TEKNİK ÇİZİM	LİSTE FİYATI ₺	ÜRÜN KT. AD.
	602 120 640	TERMOSTATİK KOMPAKT RADYATÖR VALFİ TRV3 kafa+ iç kompakt ventil		76	7
		<ul style="list-style-type: none"> İçten contalı tip (41,3 mm) Debi içi ayarlı valfi ile birlikte 15°C Ortam Sıcaklığı Alt Limitli 			
	602 120 796	TERMOSTATİK KOMPAKT RADYATÖR VALFİ TRV4 kafa + iç kompakt ventil		81	7
		<ul style="list-style-type: none"> Dıştan contalı, uzun tip (44 mm) Debi içi ayarlı valfi ile birlikte 15°C Ortam Sıcaklığı Alt Limitli 			
	602 120 813	TERMOSTATİK KOMPAKT RADYATÖR VALFİ TRV4 kafa + iç kompakt ventil		81	7
		<ul style="list-style-type: none"> İçten contalı tip (41,3 mm) Debi içi ayarlı valfi ile birlikte 15°C Ortam Sıcaklığı Alt Limitli 			
	602 120 814	TERMOSTATİK KOMPAKT RADYATÖR VALFİ TRV4 kafa + iç kompakt ventil		81	7
		<ul style="list-style-type: none"> Alından basmalı, kısa tip (35 mm) Debi içi ayarlı valfi ile birlikte 15°C Ortam Sıcaklığı Alt Limitli 			

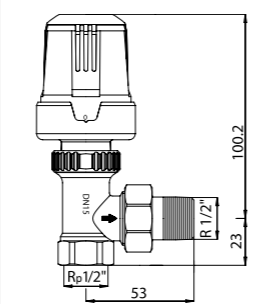
TERMOSTATİK RADYATÖR VALFLERİ (Debi İç Ayar Tertibatlı)

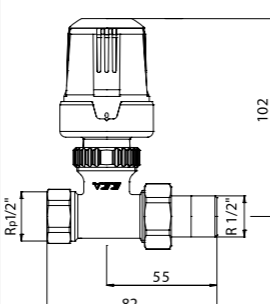
EN 215, TS EN 215, %30'a varan Enerji Tasarrufu

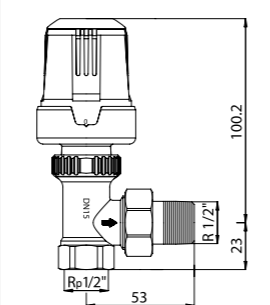
ÜRÜN	ÜRÜN KODU	ÜRÜN ADI	TEKNİK ÇİZİM	LİSTE FİYATI ₺	ÜRÜN KT. AD.
	602 120 256*	1/2" TERMOSTATİK RADYATÖR VALFİ, DÜZ TRV2		140	7
	602 120 258*	1/2" TERMOSTATİK RADYATÖR VALFİ, KÖŞE TRV2		140	7
	602 120 257*	1/2" TERMOSTATİK RADYATÖR VALFİ, DÜZ Krom - TRV		153	7
	602 120 259*	1/2" TERMOSTATİK RADYATÖR VALFİ, KÖŞE Krom - TRV		153	7

* İlgili ürünler sipariş bazında özel üretilir.

TERMOSTATİK RADYATÖR VALFLERİ (Kafa Grupları)

EN 215, TS EN 215, %30'a varan Enerji Tasarrufu

ÜRÜN	ÜRÜN KODU	ÜRÜN ADI	TEKNİK ÇİZİM	LİSTE FİYATI ₺	ÜRÜN KT. AD.
	602 120 530	TERMOSTAT Kafa GRUBU TRV3 • 15°C Ortam Sıcaklığı Alt Limitli		58	14
	602 120 170	TERMOSTAT Kafa GRUBU Krom - TRV		107	14
	602 120 754	TERMOSTAT Kafa GRUBU TRV4 • 15°C Ortam Sıcaklığı Alt Limitli		61	24

TERMOSTATİK RADYATÖR VALFLERİ (çift akış yönlü)

Çift akış yönlü Termostatik Radyatör valfi ile gerek kullanıcıya gerekse tesisatçıya yönelik yeni çözümler sunulmaktadır.

Geliştirilen yeni tipte Termostatik radyatör valflerinin sağladığı tasarruf ve konforun yanında, valfin kalorifer tesisatı ve radyatöre montajında alışlagelmiş klasik bağlantı pozisyonunun dışında mahal, çalışma, montaj ve kullanım kolaylığı dikkate alınıp, farklı konumlandırma yaparak monte edilmesi prensibinden yola çıkılmıştır. Akışkanın radyatör valfine her iki bağlantı ucundan giriş ya da çıkış yapabilmesi özelliği sayesinde radyatör valfinin değişik konumlarda radyatöre bağlantısı söz konusu olmaktadır.

Likit sensörlü termostat grubu bulunan Çift akış yönlü Termostatik Radyatör valfi bakır ve plastik boru bağlantı seçeneğinin yanında, kullanılacak bağlantı nipelini ile mevcut demir borulu kalorifer tesisatlarına da kolaylıkla monte edilebilmektedir.



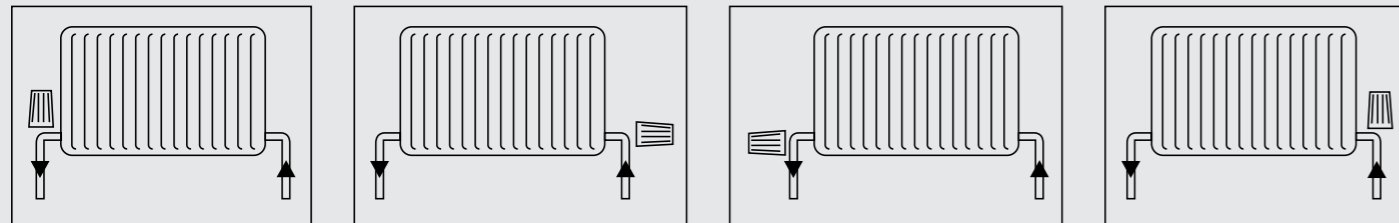

Çift akış yönlü Termostatik Radyatör valfiyle kullanıcıya;

- Aynı valfin radyatöre farklı pozisyonlarda bağlantı seçeneği,
- Bağlantı nipelinin boyunda montaj imkanları doğrultusunda ayarlama yapabilme,
- Her bir mahal sıcaklığını ayrı ayrı kontrol ederek konforlu ve ekonomik ısınmanın temini,
- Ortam içindeki diğer ısı kaynaklarında yayılan enerjinin algılanarak tasarrufa dönüşümü,
- Termostatik Radyatör valfini üç farklı şekilde ayarlama ve sabitleme,
- Fabrika çıkış ayar konumunda olduğu gibi TRV2 ve TRV3 ürünlerimiz 5-29°C arasında, TRV4 ürünlerimiz 6-28 °C arasında istenilen herhangi bir değere ayarlama imkanı,
- Tek bir değere sabitleme imkanı,
- İstenilen iki değer arasında kullanabilme imkanı,
- Bir sezonda kendini amorti edebilme,
- Estetik görünüm,
- Uzun ömürlü, bakım gerektirmeyen, kolay bir kullanım sunar.

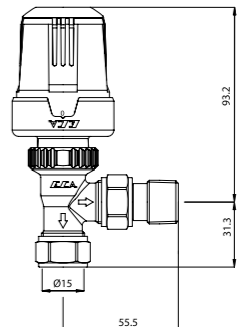

TERMOSTATİK RADYATÖR VALFLERİ (çift akış yönlü tipler)

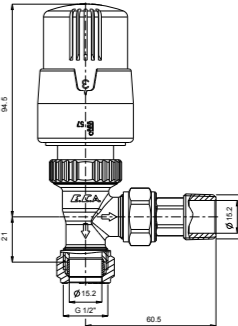
EN 215, TS EN 215, %30'a varan Enerji Tasarrufu

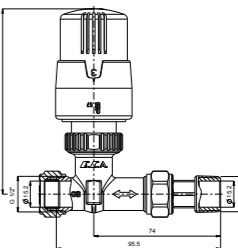





ÜRÜN	ÜRÜN KODU	ÜRÜN ADI	TEKNİK ÇİZİM	LİSTE FİYATI ₺	ÜRÜN KT. AD.
	602 120 166*	1/2" TERMOSTATİK RADYATÖR VALFİ Krom - TRV • Çift akış yönlü kullanılabilir, • Giriş çapı Ø 15 mm.		181	7
	602 120 759*	1/2" TERMOSTATİK RADYATÖR VALFİ TRV4 • Çift akış yönlü kullanılabilir, • Giriş çapı Ø 15 mm. Bakır boru • 15°C Ortam Sıcaklığı Alt Limitli		107	22
	602 120 760*	1/2" TERMOSTATİK RADYATÖR VALFİ TRV4 • Çift akış yönlü kullanılabilir, • Giriş çapı Ø 15 mm. Bakır boru • 15°C Ortam Sıcaklığı Alt Limitli		116	22

* İlgili ürünler sipariş bazında özel üretilir.

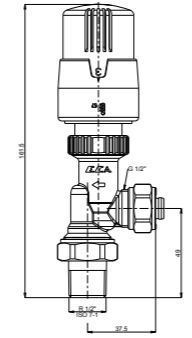
• Fiyatlara KDV ayrıca dahil edilir. Tavsiye edilen bayi satış fiyatıdır. SİRKÜLER NO: S2020101

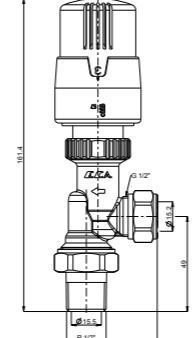
TERMOSTATİK RADYATÖR VALFLERİ (Yatay Eksenli)

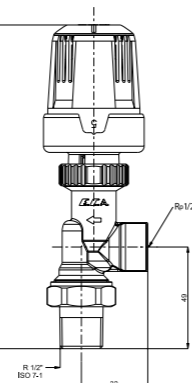

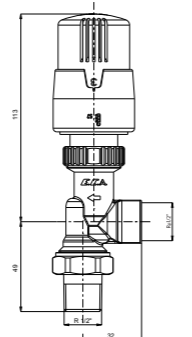

EN 215, TS EN 215, %30'a varan Enerji Tasarrufu

ÜRÜN	ÜRÜN KODU	ÜRÜN ADI	TEKNİK ÇİZİM	LİSTE FİYATI ₺	ÜRÜN KT. AD.
	602 120 879	1/2" YATAY EKSENLİ TERMOSTATİK RADYATÖR VALFİ Ø16x2mm Pex, TRV4 • 15°C Ortam Sıcaklığı Alt Limitli		111	22
	602 120 880	1/2" YATAY EKSENLİ TERMOSTATİK RADYATÖR VALFİ Ø15 Bakır Boru, TRV4 • 15°C Ortam Sıcaklığı Alt Limitli		110	22
	602 120 528*	1/2" YATAY EKSENLİ TERMOSTATİK RADYATÖR VALFİ TRV3 • 15°C Ortam Sıcaklığı Alt Limitli		101	22
	602 120 815*	1/2" YATAY EKSENLİ TERMOSTATİK RADYATÖR VALFİ TRV4 • 15°C Ortam Sıcaklığı Alt Limitli		105	22

* İlgili ürünler sipariş bazında özel üretilir.

TERMOSTATİK RADYATÖR VALFLERİ (H-Tip)

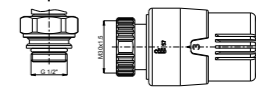
EN 215, TS EN 215, %30'a varan Enerji Tasarrufu

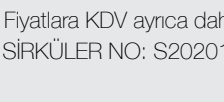
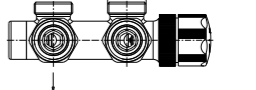
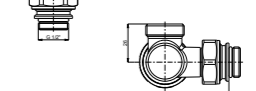
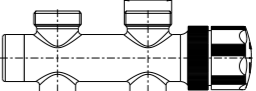
ÜRÜN	ÜRÜN KODU	ÜRÜN ADI	TEKNİK ÇİZİM	LİSTE FİYATI ₺	ÜRÜN KT. AD.
	602 120 902	TERMOSTATİK H-VALF, KÖŞE, BEYAZ (Ø 16 x 2 mm Pex) TRV4 Kafa		435	6
	602 120 ***	TERMOSTATİK H-VALF, KÖŞE, BEYAZ (Ø 16 x 2 mm Pex) TRV3 Kafa		435	6
	602 120 ***	TERMOSTATİK H-VALF, KÖŞE, BEYAZ (Ø 16 x 2 mm Pex) TRV Krom Kafa		435	6
	602 120 908	TERMOSTATİK H-VALF, DÜZ, BEYAZ (Ø 16 x 2 mm Pex) TRV4 Kafa		440	6
	602 120 ***	TERMOSTATİK H-VALF, DÜZ, BEYAZ (Ø 16 x 2 mm Pex) TRV3 Kafa		440	6
	602 120 ***	TERMOSTATİK H-VALF, DÜZ, BEYAZ (Ø 16 x 2 mm Pex) TRV Krom Kafa		440	6
	602 120 ***	TERMOSTATİK H-VALF, KÖŞE, SİYAH (Ø 16 x 2 mm Pex) TRV4 Kafa		470	6
	602 120 ***	TERMOSTATİK H-VALF, KÖŞE, SİYAH (Ø 16 x 2 mm Pex) TRV3 Kafa		470	6
	602 120 901	TERMOSTATİK H-VALF, KÖŞE, SİYAH (Ø 16 x 2 mm Pex) TRV Krom Kafa		470	6
	602 120 ***	TERMOSTATİK H-VALF, DÜZ, SİYAH (Ø 16 x 2 mm Pex) TRV4 Kafa		475	6
	602 120 ***	TERMOSTATİK H-VALF, DÜZ, SİYAH (Ø 16 x 2 mm Pex) TRV3 Kafa		475	6
	602 120 907	TERMOSTATİK H-VALF, DÜZ, SİYAH (Ø 16 x 2 mm Pex) TRV Krom Kafa		475	6

*** Sadece siparişe özel imalat yapılabilir.





TERMOSTATİK RADYATÖR VALFLERİ (H-Tip)

EN 215, TS EN 215, %30'a varan Enerji Tasarrufu

ÜRÜN	ÜRÜN KODU	ÜRÜN ADI	TEKNİK ÇİZİM	LİSTE FİYATI ₺	ÜRÜN KT. AD.
	602 120 843	TERMOSTATİK H-VALF, KÖŞE, NİKEL (Ø 16 x 2 mm Pex), TRV4 Kafa		345	6
	602 120 ***	TERMOSTATİK H-VALF, KÖŞE, NİKEL (Ø 16 x 2 mm Pex) TRV3 Kafa		345	6
	602 120 ***	TERMOSTATİK H-VALF, KÖŞE, NİKEL (Ø 16 x 2 mm Pex) TRV Krom Kafa		345	6
	602 120 836	TERMOSTATİK H-VALF, DÜZ, NİKEL (Ø 16 x 2 mm Pex) TRV4 Kafa		350	6
	602 120 ***	TERMOSTATİK H-VALF, DÜZ, NİKEL (Ø 16 x 2 mm Pex) TRV3 Kafa		350	6
	602 120 ***	TERMOSTATİK H-VALF, DÜZ, NİKEL (Ø 16 x 2 mm Pex) TRV Krom Kafa		350	6
	602 120 ***	TERMOSTATİK H-VALF, KÖŞE, KROM (Ø 16 x 2 mm Pex) TRV4 Kafa		425	6
	602 120 ***	TERMOSTATİK H-VALF, KÖŞE, KROM (Ø 16 x 2 mm Pex) TRV3 Kafa		425	6
	602 120 915	TERMOSTATİK H-VALF, KÖŞE, KROM (Ø 16 x 2 mm Pex) TRV Krom Kafa		425	6
	602 120 ***	TERMOSTATİK H-VALF, DÜZ, KROM (Ø 16 x 2 mm Pex) TRV4 Kafa		430	6
	602 120 ***	TERMOSTATİK H-VALF, DÜZ, KROM (Ø 16 x 2 mm Pex) TRV3 Kafa		430	6
	602 120 918	TERMOSTATİK H-VALF, DÜZ, KROM (Ø 16 x 2 mm Pex) TRV Krom Kafa		430	6

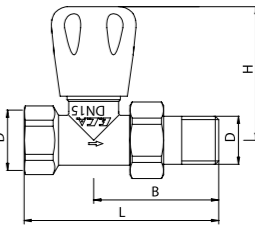
*** Sadece siparişe özel imalat yapılabilir.

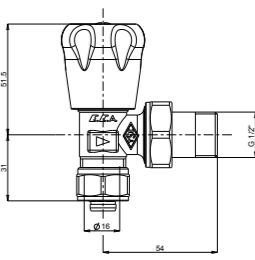

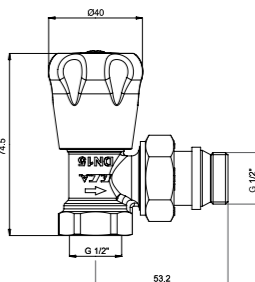

RADYATÖR VALFLERİ

ÜRÜN	ÜRÜN KODU	ÜRÜN ADI	TEKNİK ÇİZİM	LİSTE FİYATI ₺	ÜRÜN KT. AD.														
	102 120 332	1/2" RV2 KÖŞE RADYATÖR VALFİ		44	50														
	102 120 333	3/4" RV2 KÖŞE RADYATÖR VALFİ		65	35														
		<ul style="list-style-type: none"> TS 579 Sıcak Sulu Isıtma sistemleri, 10bar, 120°C <table border="1"> <thead> <tr> <th>Kod. No</th> <th>D</th> <th>L</th> <th>B</th> <th>H</th> </tr> </thead> <tbody> <tr> <td>102 120 332</td> <td>1/2"</td> <td>54.4</td> <td>23</td> <td>51.5</td> </tr> <tr> <td>102 120 333</td> <td>3/4"</td> <td>61.5</td> <td>26</td> <td>51.5</td> </tr> </tbody> </table>		Kod. No	D	L	B	H	102 120 332	1/2"	54.4	23	51.5	102 120 333	3/4"	61.5	26	51.5	
Kod. No	D	L	B	H															
102 120 332	1/2"	54.4	23	51.5															
102 120 333	3/4"	61.5	26	51.5															
	102 120 322	1/2" RV2 DÜZ RADYATÖR VALFİ		50	50														
	102 120 323	3/4" RV2 DÜZ RADYATÖR VALFİ		70	35														
		<ul style="list-style-type: none"> TS 579 Sıcak Sulu Isıtma sistemleri, 10bar, 120°C <table border="1"> <thead> <tr> <th>Kod. No</th> <th>D</th> <th>L</th> <th>B</th> <th>H</th> </tr> </thead> <tbody> <tr> <td>102 120 322</td> <td>1/2"</td> <td>83.9</td> <td>53.9</td> <td>58</td> </tr> <tr> <td>102 120 323</td> <td>3/4"</td> <td>96.5</td> <td>60.5</td> <td>58</td> </tr> </tbody> </table>		Kod. No	D	L	B	H	102 120 322	1/2"	83.9	53.9	58	102 120 323	3/4"	96.5	60.5	58	
Kod. No	D	L	B	H															
102 120 322	1/2"	83.9	53.9	58															
102 120 323	3/4"	96.5	60.5	58															
	602 120 338	KÖŞE RADYATÖR VALFİ (Ø 16 x 2 mm) Pex RV2		57	50														
		<ul style="list-style-type: none"> Sıcak Sulu Isıtma sistemleri, 10bar, 120°C 																	
	602 120 552	1/2" RV2 KÖŞE RADYATÖR VALFİ CONTALI		52	50														
		<ul style="list-style-type: none"> TS 579 Sıcak Sulu Isıtma sistemleri, 10bar, 120°C 																	

• Fiyatlara KDV ayrıca dahil edilir. Tavsiye edilen bayi satış fiyatıdır.
SİRKÜLER NO: S2020101

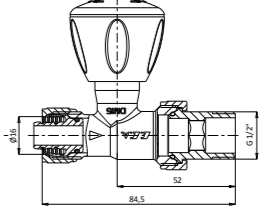
RADYATÖR VALFLERİ

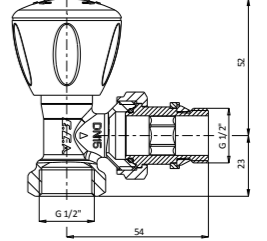
ÜRÜN	ÜRÜN KODU	ÜRÜN ADI	TEKNİK ÇİZİM	LİSTE FİYATI ₺	ÜRÜN KT. AD.
	602 120 553	1/2" RV2 DÜZ RADYATÖR VALFİ CONTALI • TS 579 • Sıcak Sulu Isıtma sistemleri, 10bar, 120°C		58	50
	602 120 641	1/2" RV3 KÖŞE RADYATÖR VALFİ • TS 579 • Sıcak Sulu Isıtma sistemleri, 10bar, 120°C		35	50
	602 120 725	1/2" RV3 DÜZ RADYATÖR VALFİ • TS 579 • Sıcak Sulu Isıtma sistemleri, 10bar, 120°C		39	50
	602 120 721	RV3 KÖŞE RADYATÖR VALFİ (Ø 16 x 2 mm) - Pex RV3 • Sıcak Sulu Isıtma sistemleri, 10bar, 120°C		39	50

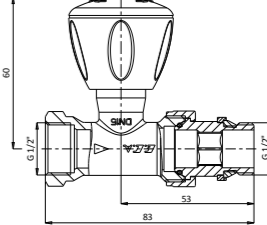
ÜRÜN	ÜRÜN KODU	ÜRÜN ADI	TEKNİK ÇİZİM	LİSTE FİYATI ₺	ÜRÜN KT. AD.
	602 120 722	RV3 DÜZ RADYATÖR VALFİ (Ø 16 x 2 mm) - Pex RV3 • Sıcak Sulu Isıtma sistemleri, 10bar, 120°C		41	50
	602 120 723	1/2" RV3 KÖŞE RADYATÖR VALFİ - CONTALI • TS 579 • Sıcak Sulu Isıtma sistemleri, 10bar, 120°C		39	50
	602 120 724	1/2" RV3 DÜZ RADYATÖR VALFİ - CONTALI • TS 579 • Sıcak Sulu Isıtma sistemleri, 10bar, 120°C		41	50





KROM RADYATÖR VALFLERİ (Havlupan Tipi Radyatörler İçin)

ÜRÜN	ÜRÜN KODU	ÜRÜN ADI	TEKNİK ÇİZİM	LİSTE FİYATI ₺	ÜRÜN KT. AD.
	602 120 371	1/2" KROM KÖŞE RADYATÖR VALFİ <ul style="list-style-type: none"> • TS 579 • Sıcak Sulu Isıtma sistemleri, 10bar, 120°C • Polisajlı krom kaplama 		75	42
	602 120 388	1/2" KROM DÜZ RADYATÖR VALFİ <ul style="list-style-type: none"> • TS 579 • Sıcak Sulu Isıtma sistemleri, 10bar, 120°C • Polisajlı krom kaplama 		80	42
	602 120 749	1/2" RV3 KROM KÖŞE RADYATÖR VALFİ <ul style="list-style-type: none"> • TS 579 • Sıcak Sulu Isıtma sistemleri, 10bar, 120°C • Krom kaplama 		53	50
	602 120 750	1/2" RV3 KROM DÜZ RADYATÖR VALFİ <ul style="list-style-type: none"> • TS 579 • Sıcak Sulu Isıtma sistemleri, 10bar, 120°C • Krom kaplama 		59	50



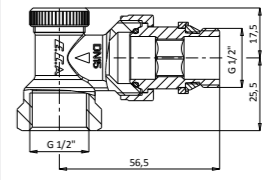

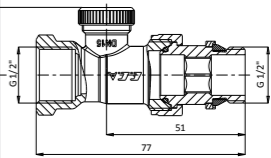

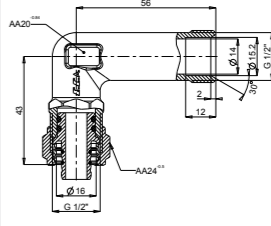
ÜRÜN	ÜRÜN KODU	ÜRÜN ADI	TEKNİK ÇİZİM	LİSTE FİYATI ₺	ÜRÜN KT. AD.
	602 120 751	1/2" RV3 KROM KÖŞE RADYATÖR VALFİ (Ø16 X 2 mm) - Pex <ul style="list-style-type: none"> • Sıcak Sulu Isıtma sistemleri, 10bar, 120°C • Krom kaplama 		65	50
	602 120 752	1/2" RV3 KROM DÜZ RADYATÖR VALFİ (Ø16 X 2 mm) - Pex <ul style="list-style-type: none"> • Sıcak Sulu Isıtma sistemleri, 10bar, 120°C • Krom kaplama 		71	50
	602 120 280	1/2" KROM, VOLANLI KÖŞE RADYATÖR VALFİ <ul style="list-style-type: none"> • TS 579 • Sıcak Sulu Isıtma sistemleri, 10bar, 120°C • Krom kaplama 		50	50
	602 120 281	1/2" KROM, VOLANLI DÜZ RADYATÖR VALFİ <ul style="list-style-type: none"> • TS 579 • Sıcak Sulu Isıtma sistemleri, 10bar, 120°C • Krom kaplama 		54	50

RADYATÖR GERİ DÖNÜŞ VALFLERİ

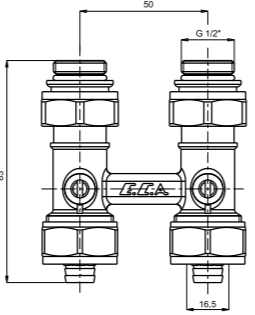

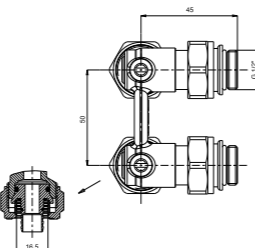

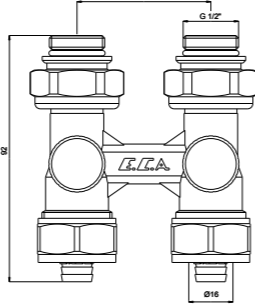

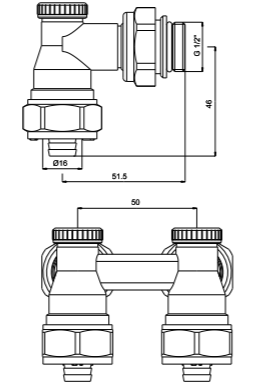
ÜRÜN	ÜRÜN KODU	ÜRÜN ADI	TEKNİK ÇİZİM	LİSTE FİYATI ₺	ÜRÜN KT. AD.
	602 120 727	1/2\" - GV3 DÜZ RADYATÖR DÖNÜŞ VALFİ Nikel • TS 579 • Sıcak Sulu Isıtma sistemleri, 10bar, 120°C		40	30
	602 120 726	1/2\" - GV3 KÖŞE RADYATÖR DÖNÜŞ VALFİ Nikel • TS 579 • Sıcak Sulu Isıtma sistemleri, 10bar, 120°C		39	40
	602 120 731	DÜZ RADYATÖR DÖNÜŞ VALFİ (Ø 16 x 2 mm) - Pex GV3 - GERİ DÖNÜŞ VALFİ • Sıcak Sulu Isıtma sistemleri, 10bar, 120°C		46	30
	602 120 730	KÖŞE RADYATÖR DÖNÜŞ VALFİ (Ø 16 x 2 mm) - Pex GV3 - GERİ DÖNÜŞ VALFİ • Sıcak Sulu Isıtma sistemleri, 10bar, 120°C		41	40

ÜRÜN	ÜRÜN KODU	ÜRÜN ADI	TEKNİK ÇİZİM	LİSTE FİYATI ₺	ÜRÜN KT. AD.
	602 120 728	1/2\" GV3 KÖŞE RADYATÖR DÖNÜŞ VALFİ CONTALI • TS 579 • Sıcak Sulu Isıtma sistemleri, 10bar, 120°C		41	40
	602 120 729	1/2\" GV3 DÜZ RADYATÖR DÖNÜŞ VALFİ CONTALI • TS 579 • Sıcak Sulu Isıtma sistemleri, 10bar, 120°C		46	30
	602 499 181	1/2\" X Ø16 MM RADYATÖR BAĞLANTI DİRSEĞİ • Sıcak Sulu Isıtma sistemleri, 10bar, 120°C		32	20

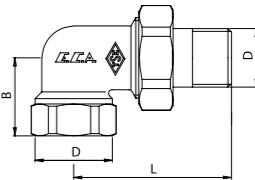

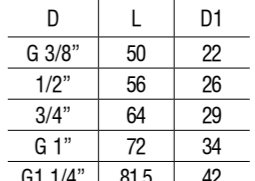

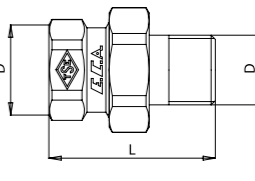
H-VALFLER (kompakt tip panel radyatörler için)

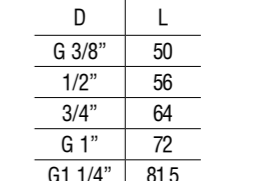
ÜRÜN	ÜRÜN KODU	ÜRÜN ADI	TEKNİK ÇİZİM	LİSTE FİYATI ₺	ÜRÜN KT. AD.
	602 120 331	1/2" x Ø16 mm KÜRESEL H-VALF, DÜZ TİP PEX BORU BAĞLANTILI • Tornavida kontrollü küre klape • Sıcak Sulu Isıtma sistemleri, 10bar, 120°C		107	7
	602 120 333	1/2" x Ø16 mm KÜRESEL H-VALF, KÖŞE TİP PEX BORU BAĞLANTILI • Tornavida kontrollü küre klape • Sıcak Sulu Isıtma sistemleri, 10bar, 120°C		112	7
	602 120 348	1/2" x Ø16 mm H-VALF STOP TİPİ, DÜZ PEX BORU BAĞLANTILI • Alyan kontrollü klape • Klape koruma kapağı • Sıcak Sulu Isıtma sistemleri, 10bar, 120°C		120	7
	602 120 349	1/2" x Ø16 mm H-VALF STOP TİPİ, KÖŞE PEX BORU BAĞLANTILI • Alyan kontrollü klape • Klape koruma kapağı • Sıcak Sulu Isıtma sistemleri, 10bar, 120°C		124	7

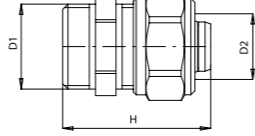

RAKORLAR

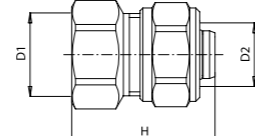
ÜRÜN	ÜRÜN KODU	ÜRÜN ADI	TEKNİK ÇİZİM	LİSTE FİYATI ₺	ÜRÜN KT. AD.																		
	601 002 001	3/8" KÖŞE RAKOR		26	100																		
	601 002 002	1/2" KÖŞE RAKOR		26	80																		
	601 002 003	3/4" KÖŞE RAKOR		37	40																		
	601 002 004	1" KÖŞE RAKOR		58	25																		
	601 002 005	1 1/4" KÖŞE RAKOR		106	15																		
			<table border="1"> <thead> <tr> <th>D</th> <th>L</th> <th>D1</th> </tr> </thead> <tbody> <tr> <td>G 3/8"</td> <td>50</td> <td>22</td> </tr> <tr> <td>1/2"</td> <td>56</td> <td>26</td> </tr> <tr> <td>3/4"</td> <td>64</td> <td>29</td> </tr> <tr> <td>G 1"</td> <td>72</td> <td>34</td> </tr> <tr> <td>G1 1/4"</td> <td>81.5</td> <td>42</td> </tr> </tbody> </table>	D	L	D1	G 3/8"	50	22	1/2"	56	26	3/4"	64	29	G 1"	72	34	G1 1/4"	81.5	42		
D	L	D1																					
G 3/8"	50	22																					
1/2"	56	26																					
3/4"	64	29																					
G 1"	72	34																					
G1 1/4"	81.5	42																					
	602 121 001	3/8" KÖŞE RAKOR, NİKEL KAPLAMALI		30	100																		
	602 121 002	1/2" KÖŞE RAKOR, NİKEL KAPLAMALI		30	80																		
	602 121 003	3/4" KÖŞE RAKOR, NİKEL KAPLAMALI		48	40																		
	602 121 004	1" KÖŞE RAKOR, NİKEL KAPLAMALI		75	25																		
	602 121 005	1 1/4" KÖŞE RAKOR, NİKEL KAPLAMALI • TS 579 • Sıcak Sulu Isıtma sistemleri, 10 bar, 120°C		119	15																		
			<table border="1"> <thead> <tr> <th>D</th> <th>L</th> <th>D1</th> </tr> </thead> <tbody> <tr> <td>G 3/8"</td> <td>50</td> <td>22</td> </tr> <tr> <td>1/2"</td> <td>56</td> <td>26</td> </tr> <tr> <td>3/4"</td> <td>64</td> <td>29</td> </tr> <tr> <td>G 1"</td> <td>72</td> <td>34</td> </tr> <tr> <td>G1 1/4"</td> <td>81.5</td> <td>42</td> </tr> </tbody> </table>	D	L	D1	G 3/8"	50	22	1/2"	56	26	3/4"	64	29	G 1"	72	34	G1 1/4"	81.5	42		
D	L	D1																					
G 3/8"	50	22																					
1/2"	56	26																					
3/4"	64	29																					
G 1"	72	34																					
G1 1/4"	81.5	42																					
	601 002 006	3/8" DÜZ RAKOR		21	125																		
	601 002 007	1/2" DÜZ RAKOR		21	100																		
	601 002 008	3/4" DÜZ RAKOR		30	70																		
	601 002 009	1" DÜZ RAKOR		48	40																		
	601 002 010	1 1/4" DÜZ RAKOR		96	25																		
			<table border="1"> <thead> <tr> <th>D</th> <th>L</th> </tr> </thead> <tbody> <tr> <td>G 3/8"</td> <td>50</td> </tr> <tr> <td>1/2"</td> <td>56</td> </tr> <tr> <td>3/4"</td> <td>64</td> </tr> <tr> <td>G 1"</td> <td>72</td> </tr> <tr> <td>G1 1/4"</td> <td>81.5</td> </tr> </tbody> </table>	D	L	G 3/8"	50	1/2"	56	3/4"	64	G 1"	72	G1 1/4"	81.5								
D	L																						
G 3/8"	50																						
1/2"	56																						
3/4"	64																						
G 1"	72																						
G1 1/4"	81.5																						
	602 121 006	3/8" DÜZ RAKOR, NİKEL KAPLAMALI		21	125																		
	602 121 007	1/2" DÜZ RAKOR, NİKEL KAPLAMALI		21	100																		
	602 121 008	3/4" DÜZ RAKOR, NİKEL KAPLAMALI		35	70																		
	602 121 009	1" DÜZ RAKOR, NİKEL KAPLAMALI		62	40																		
	602 121 010	1 1/4" DÜZ RAKOR, NİKEL KAPLAMALI • TS 579 • Sıcak Sulu Isıtma sistemleri, 10 bar, 120°C		106	25																		
			<table border="1"> <thead> <tr> <th>D</th> <th>L</th> </tr> </thead> <tbody> <tr> <td>G 3/8"</td> <td>50</td> </tr> <tr> <td>1/2"</td> <td>56</td> </tr> <tr> <td>3/4"</td> <td>64</td> </tr> <tr> <td>G 1"</td> <td>72</td> </tr> <tr> <td>G1 1/4"</td> <td>81.5</td> </tr> </tbody> </table>	D	L	G 3/8"	50	1/2"	56	3/4"	64	G 1"	72	G1 1/4"	81.5								
D	L																						
G 3/8"	50																						
1/2"	56																						
3/4"	64																						
G 1"	72																						
G1 1/4"	81.5																						

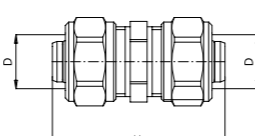
PEX BORU BAĞLANTI ELEMANLARI

ÜRÜN	ÜRÜN KODU	ÜRÜN ADI	TEKNİK ÇİZİM	LİSTE FİYATI ₺	ÜRÜN KT. AD.															
	602 199 272	1/2" x Ø16 mm DÜZ RAKOR DIŞ VİDA	 <table border="1"> <thead> <tr> <th>D1</th> <th>D2</th> <th>H</th> </tr> </thead> <tbody> <tr> <td>1/2"</td> <td>16</td> <td>36.1</td> </tr> <tr> <td>1/2"</td> <td>20</td> <td>44</td> </tr> <tr> <td>G 3/8"</td> <td>16</td> <td>35.1</td> </tr> <tr> <td>G 3/8"</td> <td>20</td> <td>46</td> </tr> </tbody> </table>	D1	D2	H	1/2"	16	36.1	1/2"	20	44	G 3/8"	16	35.1	G 3/8"	20	46	18	150
D1	D2	H																		
1/2"	16	36.1																		
1/2"	20	44																		
G 3/8"	16	35.1																		
G 3/8"	20	46																		
	602 199 273	1/2" x Ø16 mm DÜZ RAKOR İÇ VİDA	 <table border="1"> <thead> <tr> <th>D1</th> <th>D2</th> <th>H</th> </tr> </thead> <tbody> <tr> <td>1/2"</td> <td>16</td> <td>36</td> </tr> <tr> <td>1/2"</td> <td>20</td> <td>36</td> </tr> <tr> <td>3/4"</td> <td>20</td> <td>45</td> </tr> </tbody> </table>	D1	D2	H	1/2"	16	36	1/2"	20	36	3/4"	20	45	19	200			
D1	D2	H																		
1/2"	16	36																		
1/2"	20	36																		
3/4"	20	45																		
	602 199 274	Ø16 x Ø16 mm DÜZ RAKOR PEX BORU BAĞLANTILI	 <table border="1"> <thead> <tr> <th>D1</th> <th>D2</th> <th>H</th> </tr> </thead> <tbody> <tr> <td>16</td> <td>16</td> <td>51</td> </tr> <tr> <td>20</td> <td>20</td> <td>51.2</td> </tr> </tbody> </table>	D1	D2	H	16	16	51	20	20	51.2	30	150						
D1	D2	H																		
16	16	51																		
20	20	51.2																		

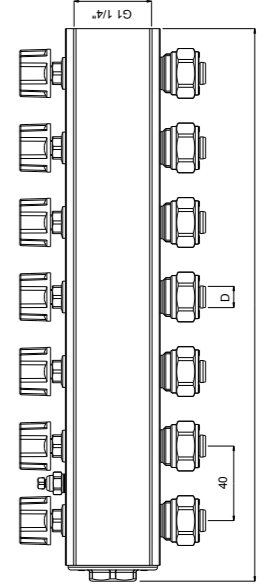
DÖŞEMEDEN DAĞITIM SİSTEMLERİ E.C.A. 01 1 1/4" debi ayar vanalı kolektörler

ÜRÜN	ÜRÜN KODU	ÜRÜN ADI	TEKNİK ÇİZİM	LİSTE FİYATI ₺	ÜRÜN KT. AD.																								
	kırmızı volanlı: 602 120 608 mavi volanlı: 602 120 601	1 1/4" DEBİ AYAR VANALI KOLEKTÖR, 7 ÇIKIŞLI Ø16 x 2 mm - Pex		477	4																								
	kırmızı volanlı: 602 120 609 mavi volanlı: 602 120 602	1 1/4" DEBİ AYAR VANALI KOLEKTÖR, 8 ÇIKIŞLI Ø16 x 2 mm - Pex		543	6																								
	kırmızı volanlı: 602 120 610 mavi volanlı: 602 120 603	1 1/4" DEBİ AYAR VANALI KOLEKTÖR, 9 ÇIKIŞLI Ø16 x 2 mm - Pex		611	6																								
	kırmızı volanlı: 602 120 611 mavi volanlı: 602 120 604	1 1/4" DEBİ AYAR VANALI KOLEKTÖR, 10 ÇIKIŞLI Ø16 x 2 mm - Pex		679	2																								
	kırmızı volanlı: 602 120 612 mavi volanlı: 602 120 605	1 1/4" DEBİ AYAR VANALI KOLEKTÖR, 11 ÇIKIŞLI Ø16 x 2 mm - Pex		747	2																								
	kırmızı volanlı: 602 120 613 mavi volanlı: 602 120 606	1 1/4" DEBİ AYAR VANALI KOLEKTÖR, 12 ÇIKIŞLI Ø16 x 2 mm - Pex		816	2																								
	kırmızı volanlı: 602 120 614 mavi volanlı: 602 120 607	1 1/4" DEBİ AYAR VANALI KOLEKTÖR, 13 ÇIKIŞLI Ø16 x 2 mm - Pex	<table border="1"> <thead> <tr> <th>Çıkış</th> <th>D</th> <th>d</th> <th>L</th> <th>B</th> <th>H</th> </tr> </thead> <tbody> <tr> <td>7</td> <td rowspan="7">G 1 1/4"</td> <td rowspan="7">Ø16x2</td> <td>296.5</td> <td rowspan="7">40</td> <td rowspan="7">95</td> </tr> <tr> <td>8</td> <td>336.5</td> </tr> <tr> <td>9</td> <td>376.5</td> </tr> <tr> <td>10</td> <td>416.5</td> </tr> <tr> <td>11</td> <td>456.5</td> </tr> <tr> <td>12</td> <td>496.5</td> </tr> <tr> <td>13</td> <td>536.5</td> </tr> </tbody> </table>	Çıkış	D	d	L	B	H	7	G 1 1/4"	Ø16x2	296.5	40	95	8	336.5	9	376.5	10	416.5	11	456.5	12	496.5	13	536.5	880	2
Çıkış	D	d	L	B	H																								
7	G 1 1/4"	Ø16x2	296.5	40	95																								
8			336.5																										
9			376.5																										
10			416.5																										
11			456.5																										
12			496.5																										
13			536.5																										

- TSEK belgeli
- Sıcak Sulu Isıtma sistemleri, sıhhi tesisatlar 10bar, 120°C
- Kolektörler üzerinde purjör bulunmaktadır.
- Körtapa dahildir.

* 17x2 mm plastik boru, 15x2 mm boru seçenekleri siparişe özel üretilecek olup ayrıca fiyatlandırılacaktır.

• Fiyatlara KDV ayrıca dahil edilir. Tavsiye edilen bayi satış fiyatıdır.
SİRKÜLER NO: S2020101

DÖŞEMEDEN DAĞITIM SİSTEMLERİ

E.C.A. 02 1" debi ayar vanalı kolektörler

ÜRÜN	ÜRÜN KODU	ÜRÜN ADI	TEKNİK ÇİZİM	LİSTE FİYATI ₺	ÜRÜN KT. AD.
	kırmızı volanlı: 602 120 695 mavi volanlı: 602 120 694	1" DEBİ AYAR VANALI KOLEKTÖR, NİKEL KAPLAMALI, 2 ÇIKIŞLI, Ø16 x 2 mm - Pex		96	5
	kırmızı volanlı: 602 120 680 mavi volanlı: 602 120 669	1" DEBİ AYAR VANALI KOLEKTÖR, NİKEL KAPLAMALI, 3 ÇIKIŞLI, Ø16 x 2 mm - Pex		134	5
	kırmızı volanlı: 602 120 681 mavi volanlı: 602 120 670	1" DEBİ AYAR VANALI KOLEKTÖR, NİKEL KAPLAMALI, 4 ÇIKIŞLI, Ø16 x 2 mm - Pex		172	9
	kırmızı volanlı: 602 120 682 mavi volanlı: 602 120 671	1" DEBİ AYAR VANALI KOLEKTÖR NİKEL KAPLAMALI, 5 ÇIKIŞLI, Ø16 x 2 mm - Pex		200	12
	kırmızı volanlı: 602 120 683 mavi volanlı: 602 120 672	1" DEBİ AYAR VANALI KOLEKTÖR, NİKEL KAPLAMALI, 6 ÇIKIŞLI, Ø16 x 2 mm - Pex		239	6
	kırmızı volanlı: 602 120 684 mavi volanlı: 602 120 673	1" DEBİ AYAR VANALI KOLEKTÖR, NİKEL KAPLAMALI, 7 ÇIKIŞLI, Ø16 x 2 mm - Pex		277	6
	kırmızı volanlı: 602 120 685 mavi volanlı: 602 120 674	1" DEBİ AYAR VANALI KOLEKTÖR, NİKEL KAPLAMALI, 8 ÇIKIŞLI, Ø16 x 2 mm - Pex		316	8
	kırmızı volanlı: 602 120 686 mavi volanlı: 602 120 675	1" DEBİ AYAR VANALI KOLEKTÖR, NİKEL KAPLAMALI, 9 ÇIKIŞLI, Ø16 x 2 mm - Pex		357	8
	kırmızı volanlı: 602 120 687 mavi volanlı: 602 120 676	1" DEBİ AYAR VANALI KOLEKTÖR, NİKEL KAPLAMALI, 10 ÇIKIŞLI, Ø16 x 2 mm - Pex		396	4
	kırmızı volanlı: 602 120 688 mavi volanlı: 602 120 677	1" DEBİ AYAR VANALI KOLEKTÖR, NİKEL KAPLAMALI, 11 ÇIKIŞLI, Ø16 x 2 mm - Pex		434	4
	kırmızı volanlı: 602 120 689 mavi volanlı: 602 120 678	1" DEBİ AYAR VANALI KOLEKTÖR, NİKEL KAPLAMALI, 12 ÇIKIŞLI, Ø16 x 2 mm - Pex		476	4
	kırmızı volanlı: 602 120 690 mavi volanlı: 602 120 679	1" DEBİ AYAR VANALI KOLEKTÖR, NİKEL KAPLAMALI, 13 ÇIKIŞLI, Ø16 x 2 mm - Pex		514	4

Çıkış	D ₁	d ₁	L	B	H
2			93,5		
3			136,5		
4			179,5		
5			222,5		
6			265,5		
7	G1"	Ø16x2	308,5	43	98,5
8			351,5		
9			394,5		
10			437,5		
11			480,5		
12			523,5		
13			566,5		

• TSEK belgeli
• Sıcak Sulu Isıtma sistemleri, 10bar, 120°C
• Kolektörler üzerinde purjör bulunmaktadır.
• Körtapa dahildir.

Sihhi Tesisatlarda

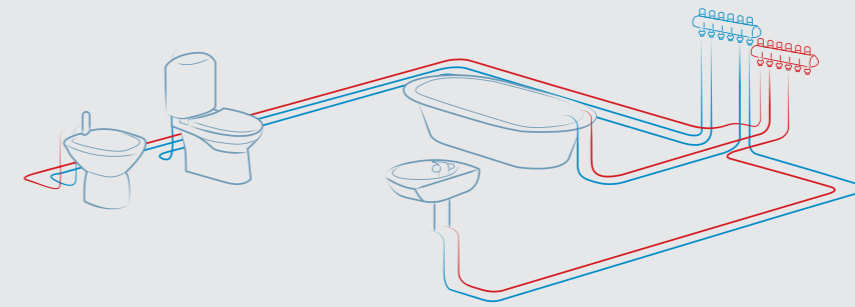

Radyatörlü Isıtma Sistemlerinde Kullanımı;

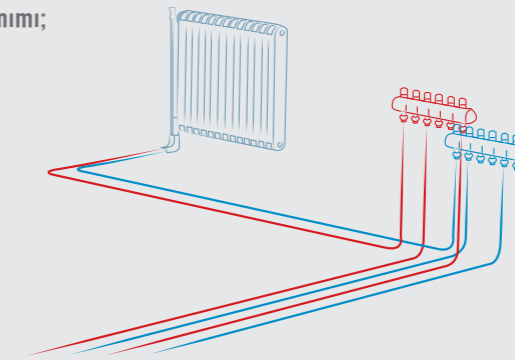



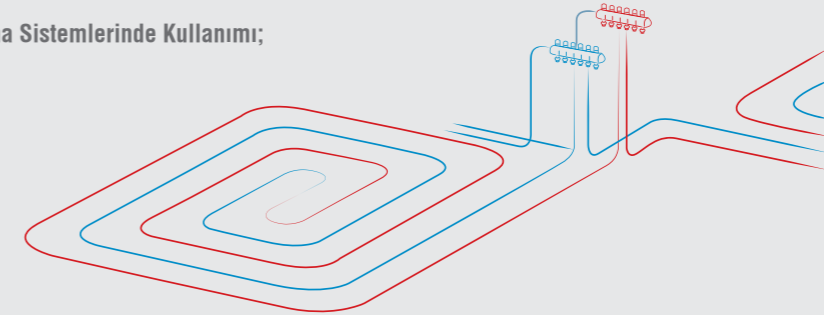

Döşmeden Isıtma Sistemlerinde Kullanımı;





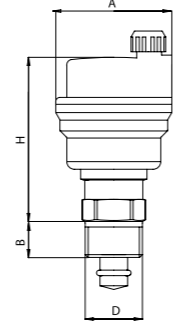

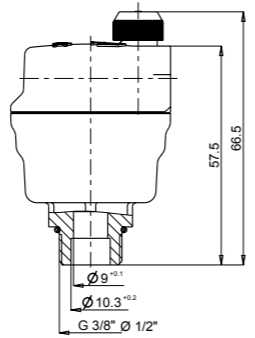
KOLEKTÖR BAĞLANTI ELEMANLARI

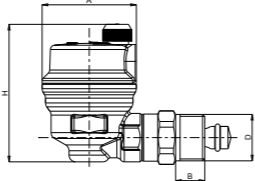
ÜRÜN	ÜRÜN KODU	ÜRÜN ADI	TEKNİK ÇİZİM	LİSTE FİYATI ₺	ÜRÜN KT. AD.
	610 212 001	KELEPÇELİ 1" KOLEKTÖR KONSOLU İKİLİ SET (E.C.A. 02 TİPİ İÇİN) • Duvar sabitleme vidaları hariçtir.		25	10

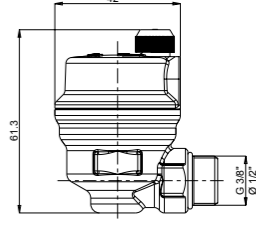

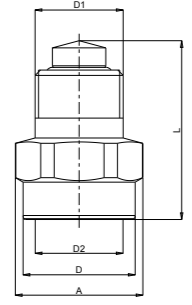
OTOMATİK HAVALANDIRICI VE PURJÖRLER

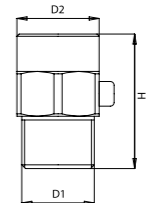
ÜRÜN	ÜRÜN KODU	ÜRÜN ADI	TEKNİK ÇİZİM	LİSTE FİYATI ₺	ÜRÜN KT. AD.												
	102 109 139	3/8" OTOMATİK HAVALANDIRICI (Çekvalfli)	 <table border="1"> <thead> <tr> <th>D1</th> <th>B</th> <th>H</th> <th>A</th> </tr> </thead> <tbody> <tr> <td>R 1/2"</td> <td>13</td> <td>59,5</td> <td>42</td> </tr> <tr> <td>R 3/4"</td> <td>13</td> <td>61</td> <td>42</td> </tr> </tbody> </table>	D1	B	H	A	R 1/2"	13	59,5	42	R 3/4"	13	61	42	83	40
	D1	B		H	A												
R 1/2"	13	59,5	42														
R 3/4"	13	61	42														
102 109 134	1/2" OTOMATİK HAVALANDIRICI (Çekvalfli)	TS 7817 • Sıcak Sulu Isıtma Sistemleri, 10bar, 110°C	85	40													
	602 109 013	3/8" OTOMATİK HAVALANDIRICI (Çekvalfsiz)	 <table border="1"> <thead> <tr> <th>D1</th> <th>D</th> <th>A</th> <th>L</th> </tr> </thead> <tbody> <tr> <td>G 3/8"</td> <td>21</td> <td>AA22</td> <td>33,5</td> </tr> <tr> <td>1/2"</td> <td>21</td> <td>AA22</td> <td>33,5</td> </tr> </tbody> </table>	D1	D	A	L	G 3/8"	21	AA22	33,5	1/2"	21	AA22	33,5	70	40
	D1	D		A	L												
G 3/8"	21	AA22	33,5														
1/2"	21	AA22	33,5														
602 109 051	1/2" OTOMATİK HAVALANDIRICI (Çekvalfsiz)	TS 7817 • Sıcak Sulu Isıtma Sistemleri, 10bar, 110°C	65	40													
	602 109 033	3/8" OTOMATİK HAVALANDIRICI - KÖŞE (Çekvalfli)	 <table border="1"> <thead> <tr> <th>D</th> <th>B</th> <th>H</th> <th>A</th> </tr> </thead> <tbody> <tr> <td>G 3/8"</td> <td>13</td> <td>61,3</td> <td>42</td> </tr> <tr> <td>1/2"</td> <td>13</td> <td>61,3</td> <td>42</td> </tr> </tbody> </table>	D	B	H	A	G 3/8"	13	61,3	42	1/2"	13	61,3	42	88	45
	D	B		H	A												
G 3/8"	13	61,3	42														
1/2"	13	61,3	42														
602 109 034	1/2" OTOMATİK HAVALANDIRICI - KÖŞE (Çekvalfli)	TS 7817 • Sıcak Sulu Isıtma Sistemleri, 10bar, 110°C	90	45													



ÜRÜN	ÜRÜN KODU	ÜRÜN ADI	TEKNİK ÇİZİM	LİSTE FİYATI ₺	ÜRÜN KT. AD.									
	602 109 037	3/8" OTOMATİK HAVALANDIRICI - KÖŞE (Çekvalfsiz)		74	45									
	602 109 052	1/2" OTOMATİK HAVALANDIRICI - KÖŞE (Çekvalfsiz)		68	45									
	102 199 150-01	3/8" OTOMATİK PURJÖR ÇEKVALFI	 <table border="1"> <thead> <tr> <th>D1</th> <th>B</th> <th>H</th> </tr> </thead> <tbody> <tr> <td>R 1/8"</td> <td>11</td> <td>18</td> </tr> <tr> <td>R 1/4"</td> <td>14</td> <td>18</td> </tr> </tbody> </table>	D1	B	H	R 1/8"	11	18	R 1/4"	14	18	15	60
	D1	B		H										
R 1/8"	11	18												
R 1/4"	14	18												
102 199 154-01	1/2" OTOMATİK PURJÖR ÇEKVALFI	16	60											
	102 109 011	1/8" E.C.A. STANDART PURJÖR	 <table border="1"> <thead> <tr> <th>D1</th> <th>B</th> <th>H</th> </tr> </thead> <tbody> <tr> <td>R 1/8"</td> <td>11</td> <td>18</td> </tr> <tr> <td>R 1/4"</td> <td>14</td> <td>18</td> </tr> </tbody> </table>	D1	B	H	R 1/8"	11	18	R 1/4"	14	18	22	50
	D1	B		H										
	R 1/8"	11		18										
R 1/4"	14	18												
102 109 012	1/4" E.C.A. STANDART PURJÖR	22	50											
110 721 089	E.C.A. PURJÖR ANAHTARI	5	50											

EMNİYET VALFLERİ

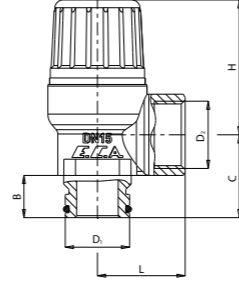
GÜNEŞ ENERJİSİ SİSTEMLERİ EMNİYET VALFİ

ÜRÜN	ÜRÜN KODU	ÜRÜN ADI	TEKNİK ÇİZİM	LİSTE FİYATI ₺	ÜRÜN KT. AD.												
	602 111 033	GÜNEŞ ENERJİSİ EMNİYET VALFİ - Ø20 O-RİNG 1/2" İÇ VİDA	<table border="1"> <tr> <td>D1</td> <td>D2</td> <td>B</td> <td>L</td> <td>C</td> <td>H</td> </tr> <tr> <td>Ø20</td> <td>1/2"</td> <td>13</td> <td>27</td> <td>25,5</td> <td>41,5</td> </tr> </table>	D1	D2	B	L	C	H	Ø20	1/2"	13	27	25,5	41,5	39	50
D1	D2	B	L	C	H												
Ø20	1/2"	13	27	25,5	41,5												
	602 111 034	GÜNEŞ ENERJİSİ EMNİYET VALFİ, 1/2" İÇxDIŞ VİDA	<table border="1"> <tr> <td>D1</td> <td>D2</td> <td>B</td> <td>L</td> <td>C</td> <td>H</td> </tr> <tr> <td>1/2"</td> <td>1/2"</td> <td>13</td> <td>27</td> <td>25,5</td> <td>41,5</td> </tr> </table>	D1	D2	B	L	C	H	1/2"	1/2"	13	27	25,5	41,5	39	50
D1	D2	B	L	C	H												
1/2"	1/2"	13	27	25,5	41,5												
	602 111 035	GÜNEŞ ENERJİSİ EMNİYET VALFİ, 1/2" İÇ VİDA <ul style="list-style-type: none"> • TS EN 4126-1 • 3 bar ayar basıncı • 110°C Sıcak Su 	<table border="1"> <tr> <td>D1</td> <td>D2</td> <td>L</td> <td>C</td> <td>H</td> </tr> <tr> <td>1/2"</td> <td>1/2"</td> <td>27</td> <td>25,5</td> <td>41,5</td> </tr> </table> 	D1	D2	L	C	H	1/2"	1/2"	27	25,5	41,5	39	50		
D1	D2	L	C	H													
1/2"	1/2"	27	25,5	41,5													

SU TESİSAT/KOMBİ EMNİYET VALFİ

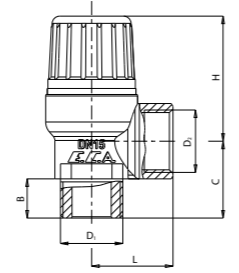
ÜRÜN	ÜRÜN KODU	ÜRÜN ADI	TEKNİK ÇİZİM	LİSTE FİYATI ₺	ÜRÜN KT. AD.												
	602 111 031	KOMBİ EMNİYET VALFİ, 1/2" İÇxDIŞ VİDA	<table border="1"> <tr> <td>D1</td> <td>D2</td> <td>B</td> <td>L</td> <td>C</td> <td>H</td> </tr> <tr> <td>1/2"</td> <td>1/2"</td> <td>13</td> <td>27</td> <td>25,5</td> <td>41,5</td> </tr> </table>	D1	D2	B	L	C	H	1/2"	1/2"	13	27	25,5	41,5	39	50
D1	D2	B	L	C	H												
1/2"	1/2"	13	27	25,5	41,5												
	602 111 032	KOMBİ EMNİYET VALFİ, 1/2" İÇ VİDA <ul style="list-style-type: none"> • TS EN 4126-1 • 3 bar ayar basıncı • 110°C Sıcak Su 	<table border="1"> <tr> <td>D1</td> <td>D2</td> <td>L</td> <td>C</td> <td>H</td> </tr> <tr> <td>1/2"</td> <td>1/2"</td> <td>27</td> <td>25,5</td> <td>41,5</td> </tr> </table> 	D1	D2	L	C	H	1/2"	1/2"	27	25,5	41,5	39	50		
D1	D2	L	C	H													
1/2"	1/2"	27	25,5	41,5													

DOĞALGAZ KÜRESEL VALFLERİ - MOP 0.5

(Bina İçi Doğalgaz Tesisatları için)

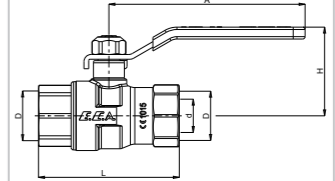

ÜRÜN	ÜRÜN KODU	ÜRÜN ADI	TEKNİK ÇİZİM	LİSTE FİYATI ₺	ÜRÜN KT. AD.																																			
	602 122 151	1/2" DOĞALGAZ KÜRESEL VALFİ	 <table border="1"> <tr> <td>D</td> <td>d</td> <td>L</td> <td>A</td> <td>H</td> </tr> <tr> <td>Rp 1/2"</td> <td>14</td> <td>59.2</td> <td>82.5</td> <td>37.3</td> </tr> <tr> <td>Rp 3/4"</td> <td>19</td> <td>68.2</td> <td>82.5</td> <td>40.7</td> </tr> <tr> <td>Rp 1"</td> <td>24</td> <td>83</td> <td>100</td> <td>47.5</td> </tr> <tr> <td>Rp1 1/4"</td> <td>30</td> <td>97</td> <td>154.5</td> <td>64.3</td> </tr> <tr> <td>Rp1 1/2"</td> <td>38</td> <td>103</td> <td>154.5</td> <td>69.3</td> </tr> <tr> <td>Rp 2"</td> <td>47</td> <td>127</td> <td>185</td> <td>79.5</td> </tr> </table>	D	d	L	A	H	Rp 1/2"	14	59.2	82.5	37.3	Rp 3/4"	19	68.2	82.5	40.7	Rp 1"	24	83	100	47.5	Rp1 1/4"	30	97	154.5	64.3	Rp1 1/2"	38	103	154.5	69.3	Rp 2"	47	127	185	79.5	35	24
D	d	L		A	H																																			
Rp 1/2"	14	59.2		82.5	37.3																																			
Rp 3/4"	19	68.2		82.5	40.7																																			
Rp 1"	24	83		100	47.5																																			
Rp1 1/4"	30	97		154.5	64.3																																			
Rp1 1/2"	38	103	154.5	69.3																																				
Rp 2"	47	127	185	79.5																																				
	602 122 152	3/4" DOĞALGAZ KÜRESEL VALFİ	43	12																																				
	602 122 153	1" DOĞALGAZ KÜRESEL VALFİ	70	15																																				
	602 122 154	1 1/4" DOĞALGAZ KÜRESEL VALFİ	153	8																																				
	602 122 155	1 1/2" DOĞALGAZ KÜRESEL VALFİ	204	6																																				
	602 122 156	2" DOĞALGAZ KÜRESEL VALFİ <ul style="list-style-type: none"> • EN331 Sistem 1'e göre 650°C - 30 dk. özel performans testinden başarı ile geçerek CE belgelidir. • Bina içi doğalgaz tesisatlarında kullanımı uygundur. 	313	3																																				

DOĞALGAZ KÜRESEL VALFLERİ - MOP 5

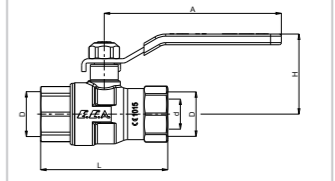
(Bina Dışı Doğalgaz Tesisatları için)

ÜRÜN	ÜRÜN KODU	ÜRÜN ADI	TEKNİK ÇİZİM	LİSTE FİYATI ₺	ÜRÜN KT. AD.																																			
	602 122 205	1/2" DOĞALGAZ KÜRESEL VALFİ	 <table border="1"> <tr> <td>D</td> <td>d</td> <td>L</td> <td>A</td> <td>H</td> </tr> <tr> <td>Rp 1/2"</td> <td>14</td> <td>59.2</td> <td>82.5</td> <td>37.3</td> </tr> <tr> <td>Rp 3/4"</td> <td>19</td> <td>68.2</td> <td>82.5</td> <td>40.7</td> </tr> <tr> <td>Rp 1"</td> <td>24</td> <td>83</td> <td>100</td> <td>47.5</td> </tr> <tr> <td>Rp1 1/4"</td> <td>30</td> <td>97</td> <td>154.5</td> <td>64.3</td> </tr> <tr> <td>Rp1 1/2"</td> <td>38</td> <td>103</td> <td>154.5</td> <td>69.3</td> </tr> <tr> <td>Rp 2"</td> <td>47</td> <td>127</td> <td>185</td> <td>79.5</td> </tr> </table>	D	d	L	A	H	Rp 1/2"	14	59.2	82.5	37.3	Rp 3/4"	19	68.2	82.5	40.7	Rp 1"	24	83	100	47.5	Rp1 1/4"	30	97	154.5	64.3	Rp1 1/2"	38	103	154.5	69.3	Rp 2"	47	127	185	79.5	34	24
D	d	L		A	H																																			
Rp 1/2"	14	59.2		82.5	37.3																																			
Rp 3/4"	19	68.2		82.5	40.7																																			
Rp 1"	24	83		100	47.5																																			
Rp1 1/4"	30	97		154.5	64.3																																			
Rp1 1/2"	38	103	154.5	69.3																																				
Rp 2"	47	127	185	79.5																																				
	602 122 206	3/4" DOĞALGAZ KÜRESEL VALFİ	41	12																																				
	602 122 207	1" DOĞALGAZ KÜRESEL VALFİ	68	15																																				
	602 122 208	1 1/4" DOĞALGAZ KÜRESEL VALFİ	149	8																																				
	602 122 209	1 1/2" DOĞALGAZ KÜRESEL VALFİ	198	6																																				
	602 122 210	2" DOĞALGAZ KÜRESEL VALFİ <ul style="list-style-type: none"> • EN331 Sistem 3'e uygundur. • Bina dışı doğalgaz tesisatlarında kullanımı uygundur. 	304	3																																				

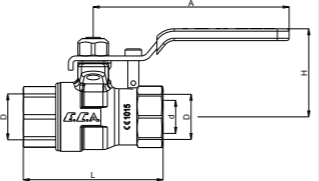
KİLİTLEMELİ DOĞALGAZ KÜRESEL VALFLERİ - MOP 0.5 (Bina İçi Doğalgaz Tesisatları için)

ÜRÜN	ÜRÜN KODU	ÜRÜN ADI	TEKNİK ÇİZİM	LİSTE FİYATI ₺	ÜRÜN KT. AD.																				
	602 122 175	1/2" KİLİTLEMELİ DOĞALGAZ KÜRESEL VALF		39	24																				
	602 122 176	3/4" KİLİTLEMELİ DOĞALGAZ KÜRESEL VALF		49	12																				
	602 122 177	1" KİLİTLEMELİ DOĞALGAZ KÜRESEL VALF		79	15																				
		<ul style="list-style-type: none"> EN331 Sistem 1'e göre 650°C - 30 dk. özel performans testinden başarı ile geçerek CE belgelidir. Bina içi doğalgaz tesisatlarında kullanımı uygundur. 																							
			<table border="1"> <thead> <tr> <th>D</th> <th>d</th> <th>L</th> <th>A</th> <th>H</th> </tr> </thead> <tbody> <tr> <td>Rp 1/2"</td> <td>14</td> <td>59.2</td> <td>83</td> <td>37.3</td> </tr> <tr> <td>Rp 3/4"</td> <td>19</td> <td>68.2</td> <td>83</td> <td>40.7</td> </tr> <tr> <td>Rp 1"</td> <td>24</td> <td>83</td> <td>100</td> <td>47.5</td> </tr> </tbody> </table>	D	d	L	A	H	Rp 1/2"	14	59.2	83	37.3	Rp 3/4"	19	68.2	83	40.7	Rp 1"	24	83	100	47.5		
D	d	L	A	H																					
Rp 1/2"	14	59.2	83	37.3																					
Rp 3/4"	19	68.2	83	40.7																					
Rp 1"	24	83	100	47.5																					
																									

İÇME SUYU KÜRESEL VALFLERİ - PN10

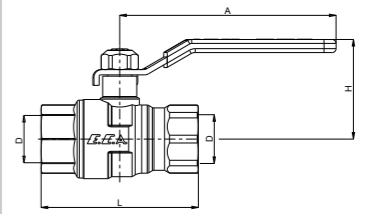
ÜRÜN	ÜRÜN KODU	ÜRÜN ADI	TEKNİK ÇİZİM	LİSTE FİYATI ₺	ÜRÜN KT. AD.																																			
	602 122 168	1/2" İÇME SUYU KÜRESEL VALFİ İÇ VE İÇ VİDA - TAM GEÇİŞLİ		35	24																																			
	602 122 169	3/4" İÇME SUYU KÜRESEL VALFİ İÇ VE İÇ VİDA - TAM GEÇİŞLİ		48	12																																			
	602 122 170	1" İÇME SUYU KÜRESEL VALFİ İÇ VE İÇ VİDA - TAM GEÇİŞLİ		76	15																																			
	602 122 182	1 1/4" İÇME SUYU KÜRESEL VALFİ İÇ VE İÇ VİDA - TAM GEÇİŞLİ		178	8																																			
	602 122 183	1 1/2" İÇME SUYU KÜRESEL VALFİ İÇ VE İÇ VİDA - TAM GEÇİŞLİ		237	6																																			
	602 122 184	2" İÇME SUYU KÜRESEL VALFİ İÇ VE İÇ VİDA - TAM GEÇİŞLİ		373	3																																			
		<ul style="list-style-type: none"> TS EN 13828 Çalışma sıcaklık Aralığı: -30°C +80°C 																																						
			<table border="1"> <thead> <tr> <th>D</th> <th>d</th> <th>L</th> <th>A</th> <th>H</th> </tr> </thead> <tbody> <tr> <td>Rp 1/2"</td> <td>Ø15</td> <td>60</td> <td>83</td> <td>38</td> </tr> <tr> <td>Rp 3/4"</td> <td>Ø20</td> <td>68.5</td> <td>83</td> <td>41.2</td> </tr> <tr> <td>Rp 1"</td> <td>Ø25</td> <td>83</td> <td>100</td> <td>47.5</td> </tr> <tr> <td>Rp 1 1/4"</td> <td>Ø32</td> <td>96.1</td> <td>154.5</td> <td>64.3</td> </tr> <tr> <td>Rp 1 1/2"</td> <td>Ø40</td> <td>109</td> <td>154.5</td> <td>71.25</td> </tr> <tr> <td>Rp 2"</td> <td>Ø50</td> <td>129</td> <td>185</td> <td>81.65</td> </tr> </tbody> </table>	D	d	L	A	H	Rp 1/2"	Ø15	60	83	38	Rp 3/4"	Ø20	68.5	83	41.2	Rp 1"	Ø25	83	100	47.5	Rp 1 1/4"	Ø32	96.1	154.5	64.3	Rp 1 1/2"	Ø40	109	154.5	71.25	Rp 2"	Ø50	129	185	81.65		
D	d	L	A	H																																				
Rp 1/2"	Ø15	60	83	38																																				
Rp 3/4"	Ø20	68.5	83	41.2																																				
Rp 1"	Ø25	83	100	47.5																																				
Rp 1 1/4"	Ø32	96.1	154.5	64.3																																				
Rp 1 1/2"	Ø40	109	154.5	71.25																																				
Rp 2"	Ø50	129	185	81.65																																				

ENDÜSTRİYEL TİP KÜRESEL VALFLER-PN25

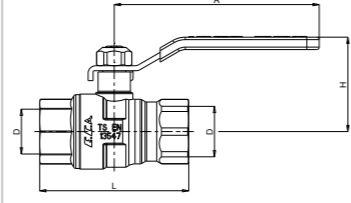
ÜRÜN	ÜRÜN KODU	ÜRÜN ADI	TEKNİK ÇİZİM	LİSTE FİYATI ₺	ÜRÜN KT. AD.																																												
	602 122 187	1/2" ENDÜSTRİYEL TİP KÜRESEL VALF İÇ VE İÇ VIDA - TAM GEÇİŞLİ		48	24																																												
	602 122 188	3/4" ENDÜSTRİYEL TİP KÜRESEL VALF İÇ VE İÇ VIDA - TAM GEÇİŞLİ		58	12																																												
	602 122 189	1" ENDÜSTRİYEL TİP KÜRESEL VALF İÇ VE İÇ VIDA - TAM GEÇİŞLİ		90	15																																												
	602 122 202	1 1/4" ENDÜSTRİYEL TİP KÜRESEL VALF İÇ VE İÇ VIDA - TAM GEÇİŞLİ		193	8																																												
	602 122 203	1 1/2" ENDÜSTRİYEL TİP KÜRESEL VALF İÇ VE İÇ VIDA - TAM GEÇİŞLİ		251	6																																												
	602 122 204	2" ENDÜSTRİYEL TİP KÜRESEL VALF İÇ VE İÇ VIDA - TAM GEÇİŞLİ		442	3																																												
	602 122 235	2 1/2" ENDÜSTRİYEL TİP KÜRESEL VALF İÇ VE İÇ VIDA - TAM GEÇİŞLİ		1.136	2																																												
	602 122 236	3" ENDÜSTRİYEL TİP KÜRESEL VALF İÇ VE İÇ VIDA - TAM GEÇİŞLİ		1.900	1																																												
		• TS CEN TS 13547 • Çalışma sıcaklık Aralığı: -30°C +80°C																																															
		<table border="1"> <thead> <tr> <th>D</th> <th>d</th> <th>L</th> <th>A</th> <th>H</th> </tr> </thead> <tbody> <tr> <td>Rp 1/2"</td> <td>Ø 15</td> <td>60</td> <td>83</td> <td>38</td> </tr> <tr> <td>Rp 3/4"</td> <td>Ø 20</td> <td>68,5</td> <td>83</td> <td>41,2</td> </tr> <tr> <td>Rp 1"</td> <td>Ø 25</td> <td>83</td> <td>100</td> <td>47,5</td> </tr> <tr> <td>Rp 1 1/4"</td> <td>Ø 32</td> <td>96,1</td> <td>154,5</td> <td>64,3</td> </tr> <tr> <td>Rp 1 1/2"</td> <td>Ø 40</td> <td>109</td> <td>154,5</td> <td>71,25</td> </tr> <tr> <td>Rp 2"</td> <td>Ø 50</td> <td>129</td> <td>185</td> <td>81,65</td> </tr> <tr> <td>Rp 2 1/2"</td> <td>Ø 64</td> <td>150,6</td> <td>249,3</td> <td>112,8</td> </tr> <tr> <td>Rp 2"</td> <td>Ø 76</td> <td>165</td> <td>249,3</td> <td>123,8</td> </tr> </tbody> </table>		D	d	L	A	H	Rp 1/2"	Ø 15	60	83	38	Rp 3/4"	Ø 20	68,5	83	41,2	Rp 1"	Ø 25	83	100	47,5	Rp 1 1/4"	Ø 32	96,1	154,5	64,3	Rp 1 1/2"	Ø 40	109	154,5	71,25	Rp 2"	Ø 50	129	185	81,65	Rp 2 1/2"	Ø 64	150,6	249,3	112,8	Rp 2"	Ø 76	165	249,3	123,8	
D	d	L	A	H																																													
Rp 1/2"	Ø 15	60	83	38																																													
Rp 3/4"	Ø 20	68,5	83	41,2																																													
Rp 1"	Ø 25	83	100	47,5																																													
Rp 1 1/4"	Ø 32	96,1	154,5	64,3																																													
Rp 1 1/2"	Ø 40	109	154,5	71,25																																													
Rp 2"	Ø 50	129	185	81,65																																													
Rp 2 1/2"	Ø 64	150,6	249,3	112,8																																													
Rp 2"	Ø 76	165	249,3	123,8																																													

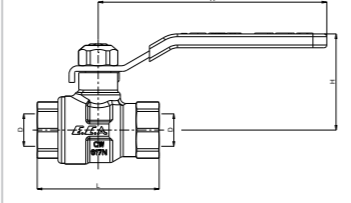

ENDÜSTRİYEL TİP KÜRESEL VALFLER-PN40

ÜRÜN	ÜRÜN KODU	ÜRÜN ADI	TEKNİK ÇİZİM	LİSTE FİYATI ₺	ÜRÜN KT. AD.																													
	602 122 228	1/4" ENDÜSTRİYEL TİP KÜRESEL VALF İÇ VE İÇ VIDA - TAM GEÇİŞLİ		58	24																													
	602 122 229	3/8" ENDÜSTRİYEL TİP KÜRESEL VALF İÇ VE İÇ VIDA - TAM GEÇİŞLİ		58	24																													
	602 122 230	1/2" ENDÜSTRİYEL TİP KÜRESEL VALF İÇ VE İÇ VIDA - TAM GEÇİŞLİ		59	24																													
	602 122 231	3/4" ENDÜSTRİYEL TİP KÜRESEL VALF İÇ VE İÇ VIDA - TAM GEÇİŞLİ		74	12																													
	602 122 232	1" ENDÜSTRİYEL TİP KÜRESEL VALF İÇ VE İÇ VIDA - TAM GEÇİŞLİ		114	15																													
		• TS CEN TS 13547 • Çalışma sıcaklık Aralığı: -30°C +80°C																																
		<table border="1"> <thead> <tr> <th>D</th> <th>d</th> <th>L</th> <th>A</th> <th>H</th> </tr> </thead> <tbody> <tr> <td>G 1/4"</td> <td>Ø 10</td> <td>44</td> <td>83</td> <td>35,3</td> </tr> <tr> <td>G 3/8"</td> <td>Ø 11</td> <td>46</td> <td>83</td> <td>36</td> </tr> <tr> <td>1/2"</td> <td>Ø 14</td> <td>50</td> <td>83</td> <td>37</td> </tr> <tr> <td>3/4"</td> <td>Ø 19</td> <td>58</td> <td>83</td> <td>40,5</td> </tr> <tr> <td>G 1"</td> <td>Ø 24</td> <td>71</td> <td>100</td> <td>46,5</td> </tr> </tbody> </table>	D	d	L	A	H	G 1/4"	Ø 10	44	83	35,3	G 3/8"	Ø 11	46	83	36	1/2"	Ø 14	50	83	37	3/4"	Ø 19	58	83	40,5	G 1"	Ø 24	71	100	46,5		
D	d	L	A	H																														
G 1/4"	Ø 10	44	83	35,3																														
G 3/8"	Ø 11	46	83	36																														
1/2"	Ø 14	50	83	37																														
3/4"	Ø 19	58	83	40,5																														
G 1"	Ø 24	71	100	46,5																														

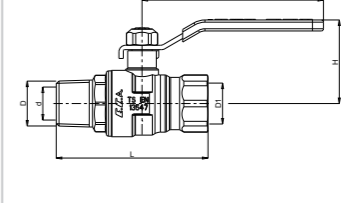
ENDÜSTRİYEL TİP KÜRESEL VALFLER-PN25

ÜRÜN	ÜRÜN KODU	ÜRÜN ADI	TEKNİK ÇİZİM	LİSTE FİYATI ₺	ÜRÜN KT. AD.																																									
	602 122 237	1/2" ENDÜSTRİYEL TİP KÜRESEL VALF İÇ VE DIŞ VIDA - TAM GEÇİŞLİ		49	24																																									
	602 122 238	3/4" ENDÜSTRİYEL TİP KÜRESEL VALF İÇ VE DIŞ VIDA - TAM GEÇİŞLİ		61	12																																									
	602 122 239	1" ENDÜSTRİYEL TİP KÜRESEL VALF İÇ VE DIŞ VIDA - TAM GEÇİŞLİ		92	15																																									
	602 122 240	1 1/4" ENDÜSTRİYEL TİP KÜRESEL VALF İÇ VE DIŞ VIDA - TAM GEÇİŞLİ		200	8																																									
	602 122 241	1 1/2" ENDÜSTRİYEL TİP KÜRESEL VALF İÇ VE DIŞ VIDA - TAM GEÇİŞLİ		260	6																																									
	602 122 242	2" ENDÜSTRİYEL TİP KÜRESEL VALF İÇ VE DIŞ VIDA - TAM GEÇİŞLİ		462	3																																									
		• TS CEN TS 13547 • Çalışma sıcaklık Aralığı: -30°C +80°C																																												
		<table border="1"> <thead> <tr> <th>D</th> <th>D1</th> <th>d</th> <th>L</th> <th>A</th> <th>H</th> </tr> </thead> <tbody> <tr> <td>R 1/2"</td> <td>Rp 1/2"</td> <td>Ø 10</td> <td>44</td> <td>83</td> <td>35,3</td> </tr> <tr> <td>R 3/4"</td> <td>Rp 3/4"</td> <td>Ø 11</td> <td>46</td> <td>83</td> <td>36</td> </tr> <tr> <td>R 1"</td> <td>Rp 1"</td> <td>Ø 14</td> <td>50</td> <td>83</td> <td>37</td> </tr> <tr> <td>R 1 1/4"</td> <td>Rp 1 1/4"</td> <td>Ø 19</td> <td>58</td> <td>83</td> <td>40,5</td> </tr> <tr> <td>R 1 1/2"</td> <td>Rp 1 1/2"</td> <td>Ø 24</td> <td>71</td> <td>100</td> <td>46,5</td> </tr> <tr> <td>R 2"</td> <td>Rp 2"</td> <td>Ø 24</td> <td>71</td> <td>100</td> <td>46,5</td> </tr> </tbody> </table>		D	D1	d	L	A	H	R 1/2"	Rp 1/2"	Ø 10	44	83	35,3	R 3/4"	Rp 3/4"	Ø 11	46	83	36	R 1"	Rp 1"	Ø 14	50	83	37	R 1 1/4"	Rp 1 1/4"	Ø 19	58	83	40,5	R 1 1/2"	Rp 1 1/2"	Ø 24	71	100	46,5	R 2"	Rp 2"	Ø 24	71	100	46,5	
D	D1	d	L	A	H																																									
R 1/2"	Rp 1/2"	Ø 10	44	83	35,3																																									
R 3/4"	Rp 3/4"	Ø 11	46	83	36																																									
R 1"	Rp 1"	Ø 14	50	83	37																																									
R 1 1/4"	Rp 1 1/4"	Ø 19	58	83	40,5																																									
R 1 1/2"	Rp 1 1/2"	Ø 24	71	100	46,5																																									
R 2"	Rp 2"	Ø 24	71	100	46,5																																									

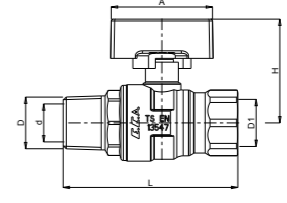
ENDÜSTRİYEL TİP KÜRESEL VALFLER - PN25

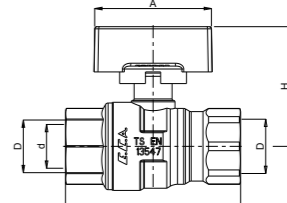



ÜRÜN	ÜRÜN KODU	ÜRÜN ADI	TEKNİK ÇİZİM	LİSTE FİYATI ₺	ÜRÜN KT. AD.																							
	KV: 602 122 243 MV: 602 122 244	1/2" ENDÜSTRİYEL TİP KÜRESEL VALF İÇ VE DIŞ VIDA - TAM GEÇİŞLİ *		49	24																							
	KV: 602 122 245 MV: 602 122 246	3/4" ENDÜSTRİYEL TİP KÜRESEL VALF İÇ VE DIŞ VIDA - TAM GEÇİŞLİ		61	12																							
	KV: 602 122 247 MV: 602 122 248	1" ENDÜSTRİYEL TİP KÜRESEL VALF İÇ VE DIŞ VIDA - TAM GEÇİŞLİ		92	15																							
		• TS CEN TS 13547 • Çalışma sıcaklık Aralığı: -30°C +80°C • 1/2"-3/4" özel plastik, 1" alüminyum volanlıdır.																										
		<table border="1"> <thead> <tr> <th>D</th> <th>D1</th> <th>d</th> <th>L</th> <th>A</th> <th>H</th> </tr> </thead> <tbody> <tr> <td>R 1/2"</td> <td>Rp 1/2"</td> <td>Ø 15</td> <td>69</td> <td>40</td> <td>41</td> </tr> <tr> <td>R 3/4"</td> <td>Rp 3/4"</td> <td>Ø 20</td> <td>77,5</td> <td>60</td> <td>48,7</td> </tr> <tr> <td>R 1"</td> <td>Rp 1"</td> <td>Ø 25</td> <td>93</td> <td>60</td> <td>53</td> </tr> </tbody> </table>	D	D1	d	L	A	H	R 1/2"	Rp 1/2"	Ø 15	69	40	41	R 3/4"	Rp 3/4"	Ø 20	77,5	60	48,7	R 1"	Rp 1"	Ø 25	93	60	53		
D	D1	d	L	A	H																							
R 1/2"	Rp 1/2"	Ø 15	69	40	41																							
R 3/4"	Rp 3/4"	Ø 20	77,5	60	48,7																							
R 1"	Rp 1"	Ø 25	93	60	53																							
	KV: 602 122 249 MV: 602 122 250	1/2" ENDÜSTRİYEL TİP KÜRESEL VALF KELEBEK VOLANLI İÇ VE İÇ VIDA - TAM GEÇİŞLİ *		48	24																							
	KV: 602 122 251 MV: 602 122 252	3/4" ENDÜSTRİYEL TİP KÜRESEL VALF KELEBEK VOLANLI İÇ VE İÇ VIDA - TAM GEÇİŞLİ		58	12																							
	KV: 602 122 253 MV: 602 122 254	1" ENDÜSTRİYEL TİP KÜRESEL VALF KELEBEK VOLANLI İÇ VE İÇ VIDA - TAM GEÇİŞLİ		90	15																							
		• TS CEN TS 13547 • Çalışma sıcaklık Aralığı: -30°C +80°C • 1/2"-3/4" özel plastik, 1" alüminyum volanlıdır.																										
		<table border="1"> <thead> <tr> <th>D</th> <th>d</th> <th>L</th> <th>A</th> <th>H</th> </tr> </thead> <tbody> <tr> <td>Rp 1/2"</td> <td>Ø 15</td> <td>60</td> <td>40</td> <td>41</td> </tr> <tr> <td>Rp 3/4"</td> <td>Ø 20</td> <td>68,5</td> <td>60</td> <td>48,7</td> </tr> <tr> <td>Rp 1"</td> <td>Ø 25</td> <td>83</td> <td>60</td> <td>53</td> </tr> </tbody> </table>	D	d	L	A	H	Rp 1/2"	Ø 15	60	40	41	Rp 3/4"	Ø 20	68,5	60	48,7	Rp 1"	Ø 25	83	60	53						
D	d	L	A	H																								
Rp 1/2"	Ø 15	60	40	41																								
Rp 3/4"	Ø 20	68,5	60	48,7																								
Rp 1"	Ø 25	83	60	53																								

KV: Kırmızı Volan MV: Mavi Volan



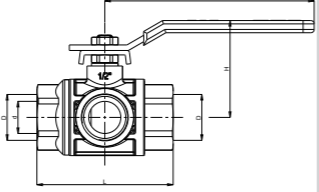

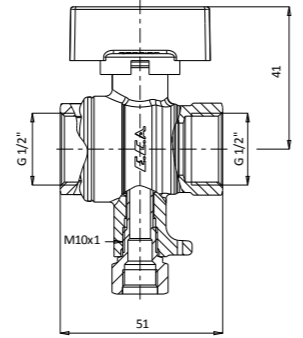
* G1/2" ölçülü ürünler plastik volanlıdır.

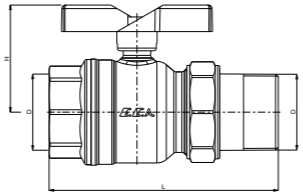
• Fiyatlara KDV ayrıca dahil edilir. Tavsiye edilen bayi satış fiyatıdır.
SİRKÜLER NO: S2020101



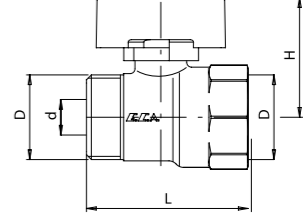

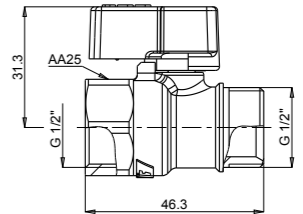
ÖZEL AMAÇLI KÜRESEL VALFLER (SU, YAĞ VE YANICI OLMAYAN GAZLAR İÇİN)

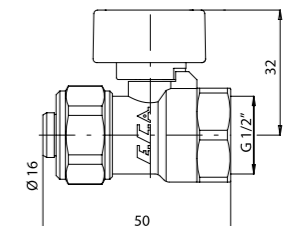
ÜRÜN	ÜRÜN KODU	ÜRÜN ADI	TEKNİK ÇİZİM	LİSTE FİYATI ₺	ÜRÜN KT. AD.																														
	102 122 131	1/4" ÜÇ YOLLU KÜRESEL VALF	 <table border="1"> <thead> <tr> <th>D</th> <th>d</th> <th>L</th> <th>A</th> <th>H</th> </tr> </thead> <tbody> <tr> <td>G 1/4"</td> <td>10</td> <td>50</td> <td>95</td> <td>41,3</td> </tr> <tr> <td>G 3/8"</td> <td>11</td> <td>52</td> <td>95</td> <td>42,2</td> </tr> <tr> <td>1/2"</td> <td>14,5</td> <td>62</td> <td>95</td> <td>44,1</td> </tr> <tr> <td>3/4"</td> <td>19</td> <td>71</td> <td>115</td> <td>52,7</td> </tr> <tr> <td>G 1"</td> <td>24</td> <td>83</td> <td>115</td> <td>56,7</td> </tr> </tbody> </table>	D	d	L	A	H	G 1/4"	10	50	95	41,3	G 3/8"	11	52	95	42,2	1/2"	14,5	62	95	44,1	3/4"	19	71	115	52,7	G 1"	24	83	115	56,7	93	24
	D	d		L	A	H																													
	G 1/4"	10		50	95	41,3																													
	G 3/8"	11		52	95	42,2																													
	1/2"	14,5		62	95	44,1																													
3/4"	19	71	115	52,7																															
G 1"	24	83	115	56,7																															
102 122 132	3/8" ÜÇ YOLLU KÜRESEL VALF	105	24																																
102 122 133	1/2" ÜÇ YOLLU KÜRESEL VALF	147	20																																
102 122 134	3/4" ÜÇ YOLLU KÜRESEL VALF	200	10																																
102 122 135	1" ÜÇ YOLLU KÜRESEL VALF	300	15																																
	602 122 149	1/2" TERMOKUPL ÇIKIŞLI KÜRESEL VALF		62	24																														
	102 122 205	1" RAKORLU KÜRESEL VALF KIRMIZI KELEBEK VOLANLI	 <table border="1"> <thead> <tr> <th>D</th> <th>d</th> <th>L</th> <th>H</th> </tr> </thead> <tbody> <tr> <td>G 1"</td> <td>Ø 25</td> <td>89</td> <td>53</td> </tr> <tr> <td>G 1 1/4"</td> <td>Ø 32</td> <td>125</td> <td>58,5</td> </tr> </tbody> </table>	D	d	L	H	G 1"	Ø 25	89	53	G 1 1/4"	Ø 32	125	58,5	102	15																		
	D	d		L	H																														
	G 1"	Ø 25		89	53																														
	G 1 1/4"	Ø 32		125	58,5																														
102 122 347	1" RAKORLU KÜRESEL VALF MAVİ KELEBEK VOLANLI	102	15																																
602 122 180	1 1/4" RAKORLU KÜRESEL VALF KIRMIZI KELEBEK VOLANLI	248	15																																
602 122 181	1 1/4" RAKORLU KÜRESEL VALF MAVİ KELEBEK VOLANLI	248	15																																

MİNİ KÜRESEL VALFLER (SU, YAĞ VE YANICI OLMAYAN GAZLAR İÇİN)

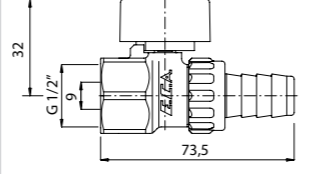
ÜRÜN	ÜRÜN KODU	ÜRÜN ADI	TEKNİK ÇİZİM	LİSTE FİYATI ₺	ÜRÜN KT. AD.																								
	102 122 027	3/8" KÜRESEL VALF, KIRMIZI VOLAN İÇİDİŞ VİDA	 <table border="1"> <thead> <tr> <th>D₁</th> <th>D₂</th> <th>d(Ø)</th> <th>L</th> <th>H</th> <th>AA/SW</th> </tr> </thead> <tbody> <tr> <td>G 3/8"</td> <td></td> <td>8</td> <td>40</td> <td>30</td> <td>22</td> </tr> <tr> <td>1/2"</td> <td></td> <td>10</td> <td>44</td> <td>32</td> <td>25</td> </tr> <tr> <td>3/4"</td> <td></td> <td>11</td> <td>50</td> <td>38</td> <td>31</td> </tr> </tbody> </table>	D ₁	D ₂	d(Ø)	L	H	AA/SW	G 3/8"		8	40	30	22	1/2"		10	44	32	25	3/4"		11	50	38	31	35	30
	D ₁	D ₂		d(Ø)	L	H	AA/SW																						
	G 3/8"			8	40	30	22																						
1/2"		10	44	32	25																								
3/4"		11	50	38	31																								
102 122 028	1/2" KÜRESEL VALF, KIRMIZI VOLAN İÇİDİŞ VİDA	40	30																										
102 122 029	3/4" KÜRESEL VALF, KIRMIZI VOLAN İÇİDİŞ VİDA	54	15																										
	602 122 003	1/2" MİNİ KÜRESEL VALF MAVİ VOLANLI İÇİDİŞ VİDA		40	30																								
	kırmızı volanlı: 102 122 031 mavi volanlı: 102 122 348	1/2" RAKORLU MİNİ KÜRESEL VALF KENDİNDEN HORTUM UÇLU Ø 16X2 mm PEX		46	24																								

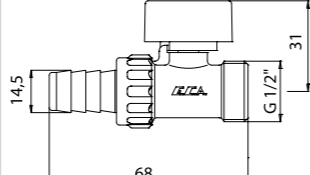
HORTUM UÇLU MİNİ KÜRESEL VALFLER (SU, YAĞ VE YANICI OLMAYAN GAZLAR İÇİN)

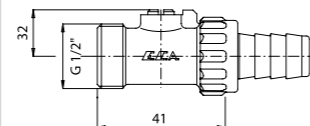
ÜRÜN	ÜRÜN KODU	ÜRÜN ADI	TEKNİK ÇİZİM	LİSTE FİYATI ₺	ÜRÜN KT. AD.
	kırmızı volanlı: 602 122 001* mavi volanlı: 602 122 009*	1/2" BOŞALTMA MUSLUĞU • TSEK • PN10 • Çalışma Sıcaklık Aralığı: -30°C +80°C • Özel Plastik T(kelebek) volan		53	24
	kırmızı volanlı: 102 122 380 mavi volanlı: 102 122 379	1/2" BOŞALTMA MUSLUĞU O - RİNGLİ • TSEK • PN10 • Çalışma Sıcaklık Aralığı: -30°C +80°C • Özel Plastik L volan • O-Ring sızdırmazlık halkalı		50	24
	602 122 004*	1/2" TORNAVİDA MİLLİ BOŞALTMA MUSLUĞU • TSEK • PN10 • Çalışma Sıcaklık Aralığı: -30C +80C • O-Ring sızdırmazlık halkalı		48	24

* İlgili ürünler sipariş bazında özel üretilir.

• Standart belgelerine ve belgelendirme kapsamındaki ürünlere www.eca.com.tr, www.valf.com.tr üzerinden ulaşılabilir.
• Katalogta yer alan resimler bilgi içindir. Elmor Tesisat Malzemeleri Tic. A.Ş. mamul fiyat ve görünüş detaylarında değişiklik yapma hakkına sahiptir.

ŞİBER VALFLER

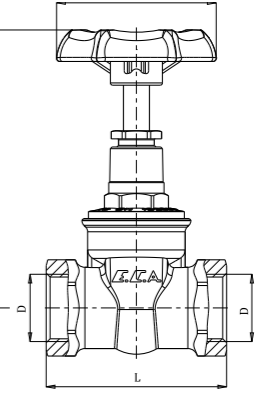
ÜRÜN	ÜRÜN KODU	ÜRÜN ADI	TEKNİK ÇİZİM	LİSTE FİYATI ₺	ÜRÜN KT. AD.																										
	601 003 019	1/2" ŞİBER VALF		68	30																										
	601 003 020	3/4" ŞİBER VALF		80	20																										
	601 003 021	1" ŞİBER VALF		136	20																										
	601 003 022	1 1/4" ŞİBER VALF		225	12																										
	601 003 023	1 1/2" ŞİBER VALF		264	12																										
	601 003 024	2" ŞİBER VALF		402	8																										
		• TS EN 12288 • Özel plastik çevirme volanı • PN 25 • Max. çalışma sıcaklığı: 90°C		<table border="1"> <thead> <tr> <th>D</th> <th>L</th> <th>H</th> <th>A</th> </tr> </thead> <tbody> <tr> <td>1/2"</td> <td>55,5</td> <td>85</td> <td>49</td> </tr> <tr> <td>3/4"</td> <td>58</td> <td>96</td> <td>59</td> </tr> <tr> <td>G 1"</td> <td>68</td> <td>103</td> <td>59</td> </tr> <tr> <td>G 1 1/4"</td> <td>78</td> <td>109</td> <td>68,5</td> </tr> <tr> <td>G 1 1/2"</td> <td>80,5</td> <td>119</td> <td>68,5</td> </tr> <tr> <td>G 2"</td> <td>93</td> <td>148</td> <td>83</td> </tr> </tbody> </table>	D	L	H	A	1/2"	55,5	85	49	3/4"	58	96	59	G 1"	68	103	59	G 1 1/4"	78	109	68,5	G 1 1/2"	80,5	119	68,5	G 2"	93	148
D	L	H	A																												
1/2"	55,5	85	49																												
3/4"	58	96	59																												
G 1"	68	103	59																												
G 1 1/4"	78	109	68,5																												
G 1 1/2"	80,5	119	68,5																												
G 2"	93	148	83																												

ŞİBER VALFLER, OPTİMİZE TİP

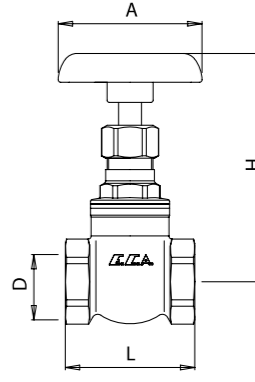
ÜRÜN	ÜRÜN KODU	ÜRÜN ADI	TEKNİK ÇİZİM	LİSTE FİYATI ₺	ÜRÜN KT. AD.																																						
	601 003 001	1/2" ŞİBER VALF		63	30																																						
	601 003 002	3/4" ŞİBER VALF		72	20																																						
	601 003 003	1" ŞİBER VALF		125	20																																						
	601 003 004	1 1/4" ŞİBER VALF		216	12																																						
	601 003 005	1 1/2" ŞİBER VALF		259	12																																						
	601 003 006	2" ŞİBER VALF		387	9																																						
	601 003 015	2 1/2" ŞİBER VALF		756	4																																						
	601 003 016	3" ŞİBER VALF		1.212	2																																						
	601 003 017	4" ŞİBER VALF		1.682	1																																						
		• Özel plastik çevirme volanı • PN 16 • Max. çalışma sıcaklığı: 90°C		<table border="1"> <thead> <tr> <th>D</th> <th>L</th> <th>H</th> <th>A</th> </tr> </thead> <tbody> <tr> <td>1/2"</td> <td>40</td> <td>89</td> <td>50</td> </tr> <tr> <td>3/4"</td> <td>49</td> <td>97</td> <td>60</td> </tr> <tr> <td>G 1"</td> <td>50</td> <td>106,5</td> <td>60</td> </tr> <tr> <td>G 1 1/4"</td> <td>58</td> <td>117</td> <td>70</td> </tr> <tr> <td>G 1 1/2"</td> <td>62</td> <td>129</td> <td>70</td> </tr> <tr> <td>G 2"</td> <td>68</td> <td>150</td> <td>80</td> </tr> <tr> <td>G 2 1/2"</td> <td>78</td> <td>180,5</td> <td>110</td> </tr> <tr> <td>G 3"</td> <td>90</td> <td>210</td> <td>110</td> </tr> <tr> <td>G 4"</td> <td>102</td> <td>221</td> <td>130</td> </tr> </tbody> </table>	D	L	H	A	1/2"	40	89	50	3/4"	49	97	60	G 1"	50	106,5	60	G 1 1/4"	58	117	70	G 1 1/2"	62	129	70	G 2"	68	150	80	G 2 1/2"	78	180,5	110	G 3"	90	210	110	G 4"	102	221
D	L	H	A																																								
1/2"	40	89	50																																								
3/4"	49	97	60																																								
G 1"	50	106,5	60																																								
G 1 1/4"	58	117	70																																								
G 1 1/2"	62	129	70																																								
G 2"	68	150	80																																								
G 2 1/2"	78	180,5	110																																								
G 3"	90	210	110																																								
G 4"	102	221	130																																								

• Fiyatlara KDV ayrıca dahil edilir. Tavsiye edilen bayi satış fiyatıdır.
SİRKÜLER NO: S2020101

STOP VALFLER

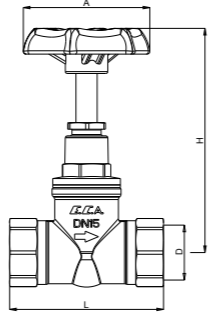
ÜRÜN	ÜRÜN KODU	ÜRÜN ADI	TEKNİK ÇİZİM	LİSTE FİYATI ₺	ÜRÜN KT. AD.																												
	601 005 031	1/2" STOP VALF	 <table border="1"> <thead> <tr> <th>D</th> <th>L</th> <th>A</th> <th>H</th> </tr> </thead> <tbody> <tr> <td>1/2"</td> <td>58</td> <td>49</td> <td>84</td> </tr> <tr> <td>3/4"</td> <td>63</td> <td>58</td> <td>94</td> </tr> <tr> <td>G 1"</td> <td>77</td> <td>58</td> <td>103</td> </tr> <tr> <td>G1 1/4"</td> <td>94</td> <td>68.4</td> <td>125</td> </tr> <tr> <td>G1 1/2"</td> <td>100</td> <td>82.7</td> <td>130.7</td> </tr> <tr> <td>G 2"</td> <td>120</td> <td>82.7</td> <td>148.7</td> </tr> </tbody> </table>	D	L	A	H	1/2"	58	49	84	3/4"	63	58	94	G 1"	77	58	103	G1 1/4"	94	68.4	125	G1 1/2"	100	82.7	130.7	G 2"	120	82.7	148.7	66	60
	D	L		A	H																												
	1/2"	58		49	84																												
	3/4"	63		58	94																												
	G 1"	77		58	103																												
	G1 1/4"	94		68.4	125																												
	G1 1/2"	100		82.7	130.7																												
G 2"	120	82.7	148.7																														
601 005 032	3/4" STOP VALF	90	35																														
601 005 033	1" STOP VALF	147	20																														
601 005 034	1 1/4" STOP VALF	230	10																														
601 005 035	1 1/2" STOP VALF	317	8																														
601 005 036	2" STOP VALF	552	6																														
		<ul style="list-style-type: none"> • TS 15 EN1213 • Özel plastik çevirme volanı • PN 10 • Max. çalışma sıcaklığı: 80°C 																															

FİLTRELER

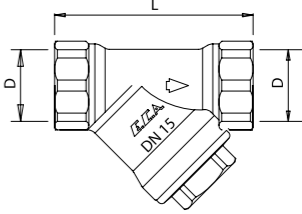
ÜRÜN	ÜRÜN KODU	ÜRÜN ADI	TEKNİK ÇİZİM	LİSTE FİYATI ₺	ÜRÜN KT. AD.														
	601 010 001	1/2" FİLTRE	 <table border="1"> <thead> <tr> <th>D</th> <th>L</th> </tr> </thead> <tbody> <tr> <td>G 1/2"</td> <td>57</td> </tr> <tr> <td>G 3/4"</td> <td>69</td> </tr> <tr> <td>G 1"</td> <td>86.7</td> </tr> <tr> <td>G 1 1/4"</td> <td>92</td> </tr> <tr> <td>G 1 1/2"</td> <td>102</td> </tr> <tr> <td>G 2"</td> <td>122</td> </tr> </tbody> </table>	D	L	G 1/2"	57	G 3/4"	69	G 1"	86.7	G 1 1/4"	92	G 1 1/2"	102	G 2"	122	50	40
	D	L																	
	G 1/2"	57																	
	G 3/4"	69																	
	G 1"	86.7																	
	G 1 1/4"	92																	
	G 1 1/2"	102																	
G 2"	122																		
601 010 002	3/4" FİLTRE	61	25																
601 010 003	1" FİLTRE	90	14																
601 010 004	1 1/4" FİLTRE	145	8																
601 010 005	1 1/2" FİLTRE	190	5																
601 010 006	2" FİLTRE	334	3																
		<ul style="list-style-type: none"> • TSEK • Çalışma basıncı : 25 bar • Max. çalışma sıcaklığı : -30°C, +80°C • Özel paslanmaz çelik filtre (140 delik/cm2) 																	

KOSVA VALFLER

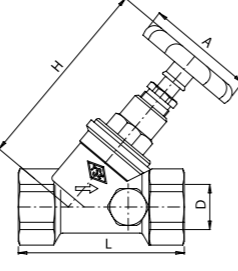
ÜRÜN	ÜRÜN KODU	ÜRÜN ADI	TEKNİK ÇİZİM	LİSTE FİYATI ₺	ÜRÜN KT. AD.																												
	601 004 001	1/2" KOSVA VALF	 <table border="1"> <thead> <tr> <th>D</th> <th>L</th> <th>H</th> <th>A</th> </tr> </thead> <tbody> <tr> <td>1/2"</td> <td>57</td> <td>50</td> <td>84,5</td> </tr> <tr> <td>3/4"</td> <td>67</td> <td>60</td> <td>100</td> </tr> <tr> <td>G 1"</td> <td>78</td> <td>60</td> <td>118</td> </tr> <tr> <td>G 1 1/4"</td> <td>92</td> <td>70</td> <td>137</td> </tr> <tr> <td>G 1 1/2"</td> <td>102</td> <td>80</td> <td>152</td> </tr> <tr> <td>G 2"</td> <td>122</td> <td>90</td> <td>177</td> </tr> </tbody> </table>	D	L	H	A	1/2"	57	50	84,5	3/4"	67	60	100	G 1"	78	60	118	G 1 1/4"	92	70	137	G 1 1/2"	102	80	152	G 2"	122	90	177	97	40
	D	L		H	A																												
	1/2"	57		50	84,5																												
	3/4"	67		60	100																												
	G 1"	78		60	118																												
	G 1 1/4"	92		70	137																												
G 1 1/2"	102	80	152																														
G 2"	122	90	177																														
601 004 002	3/4" KOSVA VALF	125	25																														
601 004 003	1" KOSVA VALF	182	15																														
601 004 004	1 1/4" KOSVA VALF	334	12																														
601 004 005	1 1/2" KOSVA VALF	391	8																														
601 004 006	2" KOSVA VALF	607	5																														
		<ul style="list-style-type: none"> • Özel plastik çevirme volanı • Akış çıkış yönünde, sağ ve sol yana takılabilen özel plastik akuple boşaltma vanalı • PN 10 • Max. çalışma sıcaklığı: 80°C 																															

ÇALPARA ÇEKVALF

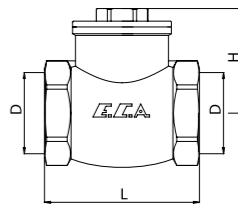
ÜRÜN	ÜRÜN KODU	ÜRÜN ADI	TEKNİK ÇİZİM	LİSTE FİYATI ₺	ÜRÜN KT. AD.												
	101 007 092	1/2" ÇALPARA ÇEKVALF	 <table border="1"> <thead> <tr> <th>D</th> <th>L</th> <th>H</th> </tr> </thead> <tbody> <tr> <td>G 1/2"</td> <td>46,5</td> <td>31,5</td> </tr> <tr> <td>G 3/4"</td> <td>56,5</td> <td>34,5</td> </tr> <tr> <td>G 1"</td> <td>63</td> <td>39</td> </tr> </tbody> </table>	D	L	H	G 1/2"	46,5	31,5	G 3/4"	56,5	34,5	G 1"	63	39	57	40
	D	L		H													
	G 1/2"	46,5		31,5													
G 3/4"	56,5	34,5															
G 1"	63	39															
101 007 093	3/4" ÇALPARA ÇEKVALF	68	20														
101 007 094	1" ÇALPARA ÇEKVALF	94	14														
		<ul style="list-style-type: none"> • TS EN 1074-3 • Özel askı tasarımı ile sarkaç tipi çalışan, kauçuk contalı klape grubu • Çalışma basıncı : 25 bar • Maksimum çalışma sıcaklığı : +80°C 															

YATAY ÇEKVALF

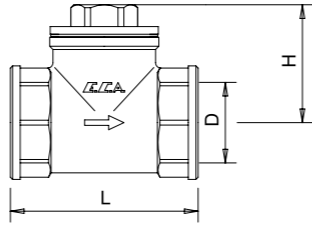
ÜRÜN	ÜRÜN KODU	ÜRÜN ADI	TEKNİK ÇİZİM	LİSTE FİYATI ₺	ÜRÜN KT. AD.																					
	601 007 022	1/2" ÇEKVALF	 <table border="1"> <thead> <tr> <th>D</th> <th>L</th> <th>H</th> </tr> </thead> <tbody> <tr> <td>G 1/2"</td> <td>55</td> <td>32</td> </tr> <tr> <td>G 3/4"</td> <td>65</td> <td>36,5</td> </tr> <tr> <td>G 1"</td> <td>75</td> <td>39,3</td> </tr> <tr> <td>G 1 1/4"</td> <td>88</td> <td>49,8</td> </tr> <tr> <td>G 1 1/2"</td> <td>98</td> <td>56,3</td> </tr> <tr> <td>G 2"</td> <td>116</td> <td>66</td> </tr> </tbody> </table>	D	L	H	G 1/2"	55	32	G 3/4"	65	36,5	G 1"	75	39,3	G 1 1/4"	88	49,8	G 1 1/2"	98	56,3	G 2"	116	66	76	35
	D	L		H																						
	G 1/2"	55		32																						
	G 3/4"	65		36,5																						
	G 1"	75		39,3																						
	G 1 1/4"	88		49,8																						
	G 1 1/2"	98		56,3																						
G 2"	116	66																								
601 007 023	3/4" ÇEKVALF	105	14																							
601 007 024	1" ÇEKVALF	154	14																							
601 007 025	1 1/4" ÇEKVALF	279	6																							
601 007 026	1 1/2" ÇEKVALF	371	10																							
601 007 027	2" ÇEKVALF	552	5																							
		<ul style="list-style-type: none"> • TS EN 1074-3 • Klape tasarımından dolayı yatay monte edilmelidir. • Çalışma basıncı : 25 bar • Maksimum çalışma sıcaklığı : +80°C 																								

KUYU ÇEKVALF

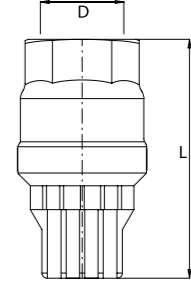
ÜRÜN	ÜRÜN KODU	ÜRÜN ADI	TEKNİK ÇİZİM	LİSTE FİYATI ₺	ÜRÜN KT. AD.												
	601 007 017	3/4" KUYU ÇEKVALF	 <table border="1"> <thead> <tr> <th>D</th> <th>L</th> </tr> </thead> <tbody> <tr> <td>G 3/4"</td> <td>80</td> </tr> <tr> <td>G 1"</td> <td>93</td> </tr> <tr> <td>G 1 1/4"</td> <td>100</td> </tr> <tr> <td>G 1 1/2"</td> <td>110</td> </tr> <tr> <td>G 2"</td> <td>120</td> </tr> </tbody> </table>	D	L	G 3/4"	80	G 1"	93	G 1 1/4"	100	G 1 1/2"	110	G 2"	120	58	20
	D	L															
	G 3/4"	80															
	G 1"	93															
	G 1 1/4"	100															
	G 1 1/2"	110															
	G 2"	120															
601 007 018	1" KUYU ÇEKVALF	68	15														
601 007 019	1 1/4" KUYU ÇEKVALF	107	15														
601 007 020	1 1/2" KUYU ÇEKVALF	150	8														
601 007 021	2" KUYU ÇEKVALF	234	6														
		<ul style="list-style-type: none"> • TS EN 1074-3 • Özel tasarımlı, yay mekanizmalı klape grubu • Giriş tarafı plastik süzgeçli • Çalışma basıncı : 25 bar • Maksimum çalışma sıcaklığı : +80°C 															



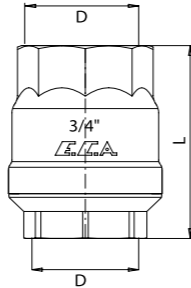



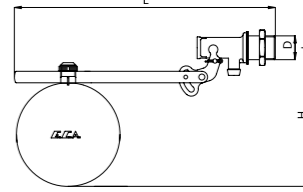



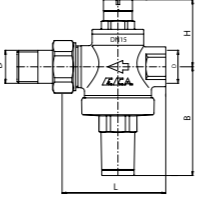

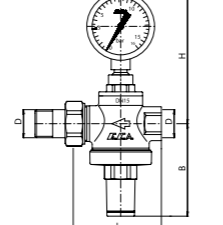
YAYLI ÇEKVALF

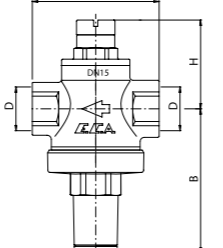

ÜRÜN	ÜRÜN KODU	ÜRÜN ADI	TEKNİK ÇİZİM	LİSTE FİYATI ₺	ÜRÜN KT. AD.														
	601 007 007	1/2" YAYLI ÇEKVALF	 <table border="1"> <thead> <tr> <th>D</th> <th>L</th> </tr> </thead> <tbody> <tr> <td>G 1/2"</td> <td>40</td> </tr> <tr> <td>G 3/4"</td> <td>50</td> </tr> <tr> <td>G 1"</td> <td>62,5</td> </tr> <tr> <td>G 1 1/4"</td> <td>67</td> </tr> <tr> <td>G 1 1/2"</td> <td>77</td> </tr> <tr> <td>G 2"</td> <td>85</td> </tr> </tbody> </table>	D	L	G 1/2"	40	G 3/4"	50	G 1"	62,5	G 1 1/4"	67	G 1 1/2"	77	G 2"	85	41	40
	D	L																	
	G 1/2"	40																	
	G 3/4"	50																	
	G 1"	62,5																	
	G 1 1/4"	67																	
	G 1 1/2"	77																	
G 2"	85																		
601 007 008	3/4" YAYLI ÇEKVALF	48	15																
601 007 009	1" YAYLI ÇEKVALF	68	10																
601 007 010	1 1/4" YAYLI ÇEKVALF	97	6																
601 007 011	1 1/2" YAYLI ÇEKVALF	176	4																
601 007 012	2" YAYLI ÇEKVALF	255	3																
		<ul style="list-style-type: none"> • TS EN 1074-3 • Özel tasarımlı, yay mekanizmalı klape grubu • Çalışma basıncı: 25 bar • Maksimum çalışma sıcaklığı : +80°C 																	

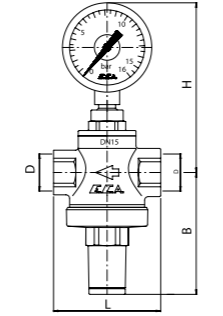
FLATÖRLER

ÜRÜN	ÜRÜN KODU	ÜRÜN ADI	TEKNİK ÇİZİM	LİSTE FİYATI ₺	ÜRÜN KT. AD.																								
	101 009 001	3/8" FLATÖR	 <table border="1"> <thead> <tr> <th>D</th> <th>L</th> <th>H</th> </tr> </thead> <tbody> <tr> <td>G 3/8"</td> <td>348</td> <td>95</td> </tr> <tr> <td>1/2"</td> <td>335</td> <td>95</td> </tr> <tr> <td>3/4"</td> <td>375</td> <td>107,3</td> </tr> <tr> <td>G 1"</td> <td>375</td> <td>107,3</td> </tr> <tr> <td>G 1 1/4"</td> <td>415</td> <td>96,2</td> </tr> <tr> <td>G 1 1/2"</td> <td>415</td> <td>96,2</td> </tr> <tr> <td>G 2"</td> <td>415</td> <td>96,2</td> </tr> </tbody> </table>	D	L	H	G 3/8"	348	95	1/2"	335	95	3/4"	375	107,3	G 1"	375	107,3	G 1 1/4"	415	96,2	G 1 1/2"	415	96,2	G 2"	415	96,2	107	20
	D	L		H																									
	G 3/8"	348		95																									
	1/2"	335		95																									
	3/4"	375		107,3																									
	G 1"	375		107,3																									
	G 1 1/4"	415		96,2																									
G 1 1/2"	415	96,2																											
G 2"	415	96,2																											
101 009 002	1/2" FLATÖR	112	20																										
101 009 003	3/4" FLATÖR	141	10																										
101 009 004	1" FLATÖR	162	10																										
101 009 005	1 1/4" FLATÖR	348	4																										
101 009 006	1 1/2" FLATÖR	374	4																										
101 009 007	2" FLATÖR	457	4																										
		<ul style="list-style-type: none"> • TSEK • Çalışma basıncı : 6 bar • Maksimum çalışma sıcaklığı : +80°C • Çalışma basıncının üzerinden kullanımlarda mutlaka basınç düşürücü kullanınız. 																											

SU BASINÇ DÜŞÜRÜCÜ VALFLER

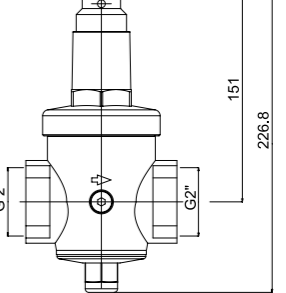
ÜRÜN	ÜRÜN KODU	ÜRÜN ADI	TEKNİK ÇİZİM	LİSTE FİYATI ₺	ÜRÜN KT. AD.
	602 111 007	1/2" BASINÇ DÜŞÜRÜCÜ VALF PİSTONLU, İÇ VIDA X RAKORLU	 D L H A 1/2" 60 68 42 3/4" 60 68 42	207	10
	102 199 160	3/4" BASINÇ DÜŞÜRÜCÜ VALF PİSTONLU, İÇ VIDA X RAKORLU		229	10
	602 111 006	1/2" MANOMETRELİ BASINÇ DÜŞÜRÜCÜ VALF PİSTONLU, İÇ VIDA X RAKORLU	 D L H A 1/2" 65 68 95 3/4" 65,8 68 95	283	6
	602 111 008	3/4" MANOMETRELİ BASINÇ DÜŞÜRÜCÜ VALF PİSTONLU, İÇ VIDA X RAKORLU		305	6
	602 111 004	1/2" BASINÇ DÜŞÜRÜCÜ VALF PİSTONLU, İÇ VIDA X İÇ VIDA	 D L B H 1/2" 60 68 48 3/4" 60 68 48 G 1" 81 97,7 59 G 1 1/4" 88 97,7 59	190	10
	602 111 009	3/4" BASINÇ DÜŞÜRÜCÜ VALF PİSTONLU, İÇ VIDA X İÇ VIDA		212	10
	602 111 038	1" BASINÇ DÜŞÜRÜCÜ VALF PİSTONLU, İÇ VIDA X İÇ VIDA		358	8
	602 111 037	1 1/4" BASINÇ DÜŞÜRÜCÜ VALF PİSTONLU, İÇ VIDA X İÇ VIDA		380	4
	602 111 005	1/2" MANOMETRELİ BASINÇ DÜŞÜRÜCÜ VALF PİSTONLU, İÇ VIDA X İÇ VIDA	 D L B H 1/2" 60 68 95 3/4" 60 68 95 G 1" 81 97,7 110,7 G 1 1/4" 88 97,7 110,7	266	6
	602 111 010	3/4" MANOMETRELİ BASINÇ DÜŞÜRÜCÜ VALF PİSTONLU, İÇ VIDA X İÇ VIDA		288	6
	602 111 042	1" MANOMETRELİ BASINÇ DÜŞÜRÜCÜ VALF PİSTONLU, İÇ VIDA X İÇ VIDA		422	8
	602 111 041	1 1/4" MANOMETRELİ BASINÇ DÜŞÜRÜCÜ VALF PİSTONLU, İÇ VIDA X İÇ VIDA		444	4

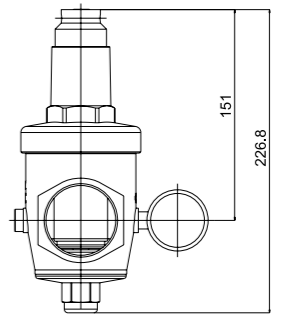
ÜRÜN	ÜRÜN KODU	ÜRÜN ADI	TEKNİK ÇİZİM	LİSTE FİYATI ₺	ÜRÜN KT. AD.
	602 111 018	2" BASINÇ DÜŞÜRÜCÜ VALF PİSTONLU, İÇ VIDA X İÇ VIDA		1.298	1
	602 111 019	2" MANOMETRELİ BASINÇ DÜŞÜRÜCÜ VALF PİSTONLU, İÇ VIDA X İÇ VIDA		1.361	1





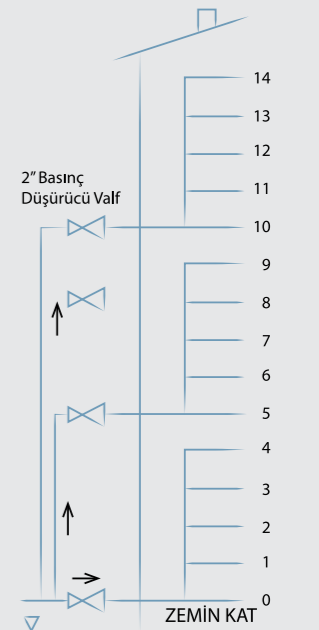
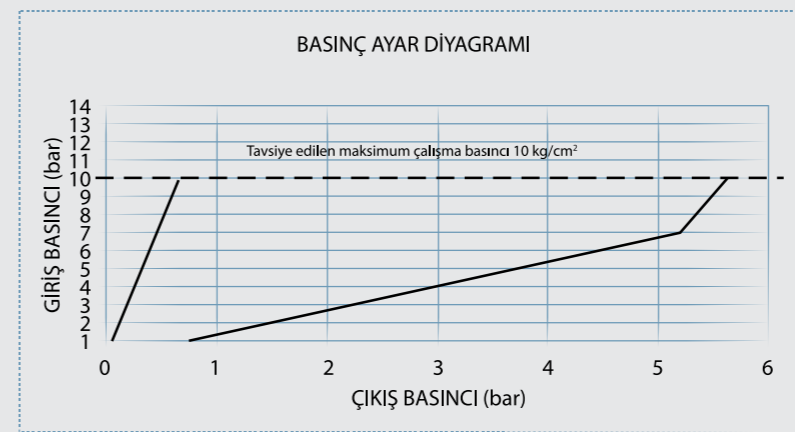

Teknik Özellikler:

- TS EN 1567
- Paslanmaz çelik Piston klape
- Çalışma basıncı: 16 bar
- Çıkış Ayar basıncı: 1~5 bar
- Fabrika ayarı: 8 bar giriş - 3 bar çıkış
- Çıkış basıncında giriş basıncına ya da ihtiyaca göre Alyan yardımı ile farklı ayar imkanı.
- Maksimum çalışma sıcaklığı : +80°C

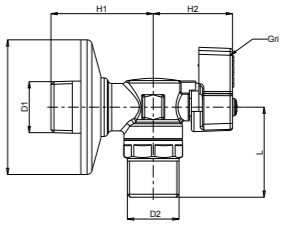

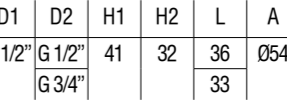

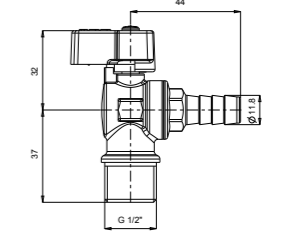

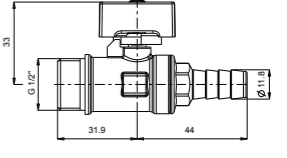
MUSLUKLAR

ÜRÜN	ÜRÜN KODU	ÜRÜN ADI	TEKNİK ÇİZİM	LİSTE FİYATI ₺	ÜRÜN KT. AD.
	102 122 041	1/2" ÇAMAŞIR - BULAŞIK MAKİNASI MUSLUĞU, ROZET DAHİL <ul style="list-style-type: none"> • TSEK • Polisajlı krom kaplama • Çalışma basıncı : 10 bar • Maksimum çalışma sıcaklığı : +80°C • Çıkış ucu 3/4" 		85	25
	102 111 018	1/2" FİLTRELİ ARA MUSLUK, UZUN TİP (ROZET DAHİL) <ul style="list-style-type: none"> • TSEK • Polisajlı krom kaplama • Çalışma basıncı : 10 bar • Maksimum çalışma sıcaklığı : +80°C • Çıkış ucu 3/8" 		80	30
	602 111 043	1/2" FİLTRELİ ARA MUSLUK, KISA TİP 3/8" ÇIKIŞ AĞIZLI (ROZET DAHİL)		37	30
	602 111 052	1/2" FİLTRELİ ARA MUSLUK, KISA TİP 1/2" ÇIKIŞ AĞIZLI (ROZET DAHİL)		37	30
	602 111 059	1/2" FİLTRELİ ARA MUSLUK, KISA TİP 3/4" ÇIKIŞ AĞIZLI (ROZET DAHİL)		41	30
	602 111 048	1/2" FİLTRELİ ARA MUSLUK, KISA TİP 3/8" ÇIKIŞ AĞIZLI KROM VOLAN - (ROZET DAHİL) <ul style="list-style-type: none"> • TSEK • Nikel kaplama • Özel plastik L volan • Çalışma basıncı : 10 bar • Maksimum çalışma sıcaklığı : +80°C • Çıkış ucu 3/8", 3/4", 1/2" 		38	30

ÜRÜN	ÜRÜN KODU	ÜRÜN ADI	TEKNİK ÇİZİM	LİSTE FİYATI ₺	ÜRÜN KT. AD.
	602 111 066	ARA MUSLUK 1/2" X 1/2" KÖŞE		49	25
	602 111 067	ARA MUSLUK 1/2" X 3/4" KÖŞE, <ul style="list-style-type: none"> • Çalışma Basıncı: 10 bar • Maksimum Çalışma Sıcaklığı: +80°C • Çıkış Ucu 3/4", 1/2" • Rozet Dahil 		50	25
	602 109 042	1/2" ARA MUSLUK, KÖŞE, HORTUM UÇLU		45	30
	602 109 043	1/2" ARA MUSLUK, DÜZ, HORTUM UÇLU <ul style="list-style-type: none"> • Çalışma Basıncı: 10 bar • Maksimum Çalışma Sıcaklığı: +80°C • Çıkış Ucu 3/8", 3/4", 1/2" 		38	30

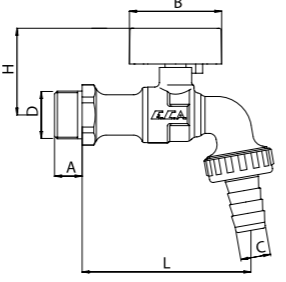
D1	D2	H1	H2	L	A
R 1/2"	G 1/2"	41	32	36	Ø54
	G 3/4"			33	

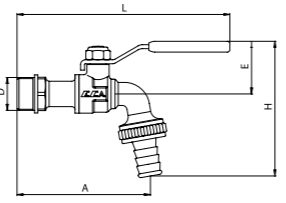

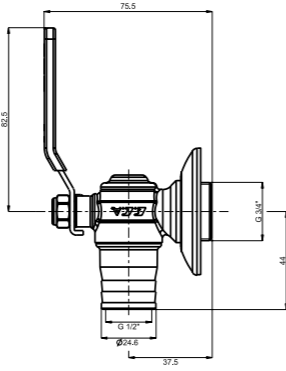
MUSLUKLAR

ÜRÜN	ÜRÜN KODU	ÜRÜN ADI	TEKNİK ÇİZİM	LİSTE FİYATI ₺	ÜRÜN KT. AD.															
	102 109 045	1/2" KÜRESEL BOŞALTIMA MUSLUĞU	 <table border="1"> <thead> <tr> <th>D</th> <th>L</th> <th>H1</th> <th>H</th> <th>D1</th> </tr> </thead> <tbody> <tr> <td>1/2"</td> <td>73</td> <td>42</td> <td>12</td> <td>59</td> </tr> <tr> <td>3/4"</td> <td>77</td> <td>43</td> <td>12</td> <td>59</td> </tr> </tbody> </table>	D	L	H1	H	D1	1/2"	73	42	12	59	3/4"	77	43	12	59	72	24
	D	L		H1	H	D1														
1/2"	73	42	12	59																
3/4"	77	43	12	59																
102 109 046	3/4" KÜRESEL BOŞALTIMA MUSLUĞU	<ul style="list-style-type: none"> TSEK Nikel kaplama Özel plastik T(kelebek) volan Rakorlu hortum ucu Çalışma basıncı : 10 bar Maksimum çalışma sıcaklığı : +80°C 	88	15																
	602 109 004	1/2" KÜRESEL BOŞALTIMA MUSLUĞU	 <table border="1"> <thead> <tr> <th>D</th> <th>L</th> <th>A</th> <th>H</th> <th>E</th> </tr> </thead> <tbody> <tr> <td>1/2"</td> <td>135,5</td> <td>85</td> <td>85,3</td> <td>35,3</td> </tr> <tr> <td>3/4"</td> <td>140,4</td> <td>89</td> <td>88</td> <td>36</td> </tr> </tbody> </table>	D	L	A	H	E	1/2"	135,5	85	85,3	35,3	3/4"	140,4	89	88	36	67	30
	D	L		A	H	E														
1/2"	135,5	85	85,3	35,3																
3/4"	140,4	89	88	36																
602 109 005	3/4" KÜRESEL BOŞALTIMA MUSLUĞU	<ul style="list-style-type: none"> TSEK Nikel kaplama 90° çevirme kolu Rakorlu hortum ucu Çalışma basıncı : 10 bar Maksimum çalışma sıcaklığı : +80°C 	82	30																
	102 109 120	3/4" KÜRESEL BAS, SABİT HORTUM UÇLU (MUSLUK ROZETİ DAHİL)		72	40															
		<ul style="list-style-type: none"> TSEK Nikel kaplama 90° çevirme kolu Sabit hortum ucu Çalışma basıncı : 10 bar Maksimum çalışma sıcaklığı : +80°C 																		

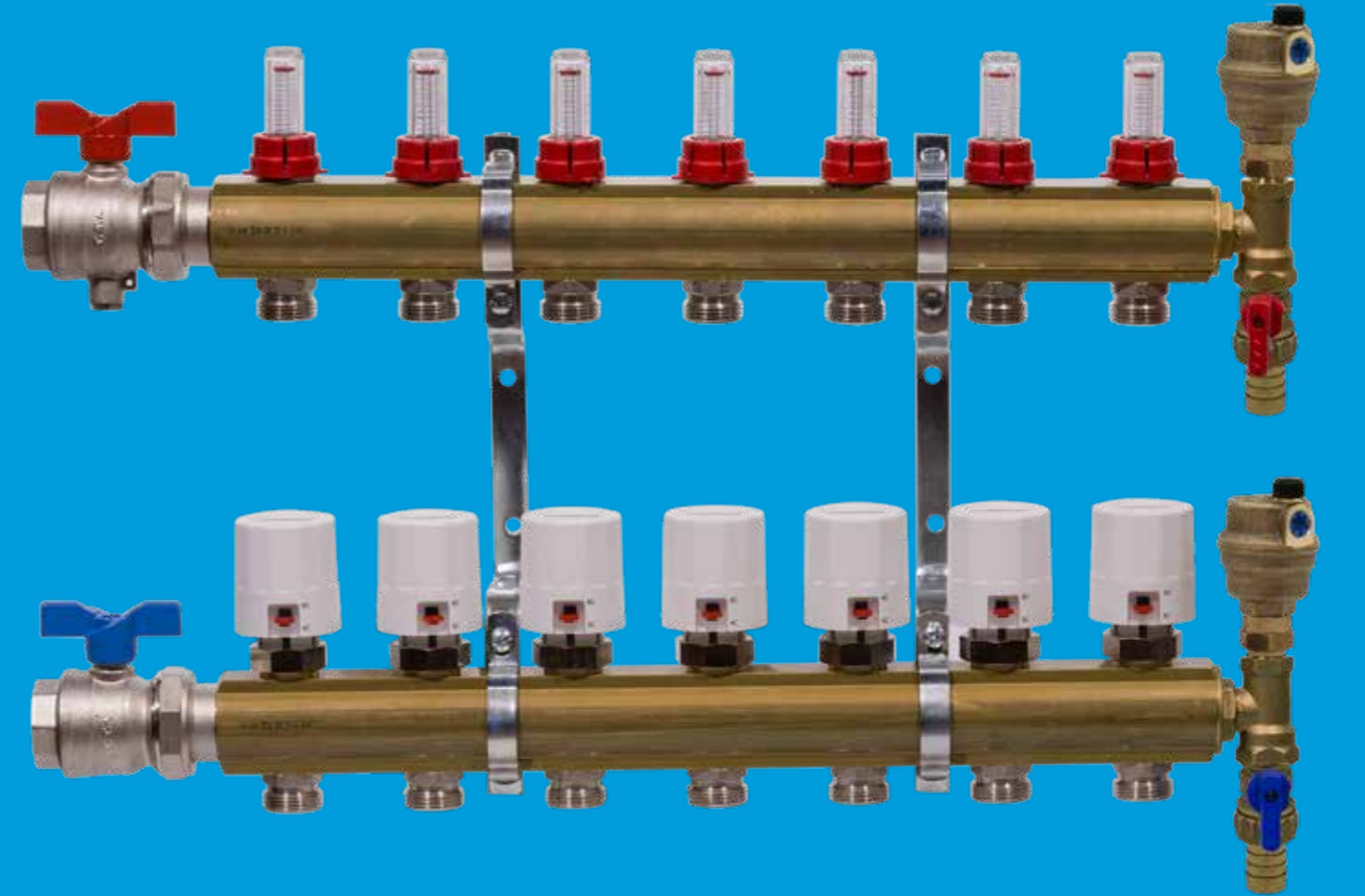
DÖŞEMEDEN ISITMA SİSTEMLERİ

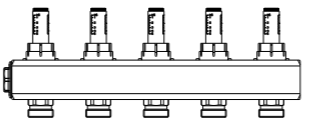
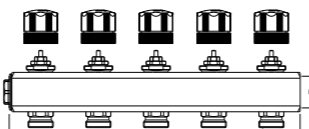

DÖŞEMEDEN ISITMA DEBİMETRELİ KOLEKTÖR SETİ

ÜRÜN	ÜRÜN KODU	ÜRÜN ADI	TEKNİK ÇİZİM	LİSTE FİYATI ₺	ÜRÜN KT. AD.																														
	601 026 097	DEBİMETRELİ KOLEKTÖR SET, 2'Lİ		426	12																														
	601 026 098	DEBİMETRELİ KOLEKTÖR SET, 3'LÜ		611	9																														
	601 026 099	DEBİMETRELİ KOLEKTÖR SET, 4'LÜ		795	6																														
	601 026 100	DEBİMETRELİ KOLEKTÖR SET, 5'Lİ		961	4																														
	601 026 101	DEBİMETRELİ KOLEKTÖR SET, 6'Lİ		1.146	4																														
	601 026 102	DEBİMETRELİ KOLEKTÖR SET, 7'Lİ		1.330	4																														
	601 026 103	DEBİMETRELİ KOLEKTÖR SET, 8'Lİ		1.497	3																														
	601 026 104	DEBİMETRELİ KOLEKTÖR SET, 9'LU		1.682	3																														
	601 026 105	DEBİMETRELİ KOLEKTÖR SET, 10'LU		1.849	3																														
	601 026 106	DEBİMETRELİ KOLEKTÖR SET, 11'Lİ		2.033	2																														
	601 026 107	DEBİMETRELİ KOLEKTÖR SET, 12'Lİ		2.218	2																														
	601 026 108	DEBİMETRELİ KOLEKTÖR SET, 13'LÜ	<table border="1"> <thead> <tr> <th>Çıkış Sayısı</th> <th>D</th> <th>d</th> <th>L</th> </tr> </thead> <tbody> <tr><td>2</td><td rowspan="13">G1"</td><td rowspan="13">3/4"</td><td>128,5</td></tr> <tr><td>3</td><td>188,5</td></tr> <tr><td>4</td><td>248,5</td></tr> <tr><td>5</td><td>308,5</td></tr> <tr><td>6</td><td>368,5</td></tr> <tr><td>7</td><td>428,5</td></tr> <tr><td>8</td><td>488,5</td></tr> <tr><td>9</td><td>548,5</td></tr> <tr><td>10</td><td>608,5</td></tr> <tr><td>11</td><td>668,5</td></tr> <tr><td>12</td><td>728,5</td></tr> <tr><td>13</td><td>788,5</td></tr> </tbody> </table>	Çıkış Sayısı	D	d	L	2	G1"	3/4"	128,5	3	188,5	4	248,5	5	308,5	6	368,5	7	428,5	8	488,5	9	548,5	10	608,5	11	668,5	12	728,5	13	788,5	2.384	2
Çıkış Sayısı	D	d	L																																
2	G1"	3/4"	128,5																																
3			188,5																																
4			248,5																																
5			308,5																																
6			368,5																																
7			428,5																																
8			488,5																																
9			548,5																																
10			608,5																																
11			668,5																																
12			728,5																																
13			788,5																																
				<ul style="list-style-type: none"> • Çalışma basıncı 6 bar • Test basıncı 10 bar (20°C) • Kullanma sıcaklığı -10°C - 70°C • Gidiş kolektörü debi ayar klapeli ve debi göstergelidir. • Dönüş kolektörü aktuatör montajına uygun hat ayar vanalıdır. • Kolektör tapaları dahildir. 																															

DÖŞEMEDEN ISITMA DEBİMETRESİZ KOLEKTÖR SETİ

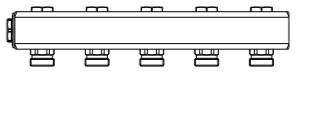
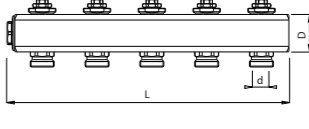
ÜRÜN	ÜRÜN KODU	ÜRÜN ADI	TEKNİK ÇİZİM	LİSTE FİYATI ₺	ÜRÜN KT. AD.																														
	601 026 109	DEBİMETRESİZ KOLEKTÖR SET, 2'Lİ		351	12																														
	601 026 110	DEBİMETRESİZ KOLEKTÖR SET, 3'LÜ		500	9																														
	601 026 111	DEBİMETRESİZ KOLEKTÖR SET, 4'LÜ		629	6																														
	601 026 112	DEBİMETRESİZ KOLEKTÖR SET, 5'Lİ		777	4																														
	601 026 113	DEBİMETRESİZ KOLEKTÖR SET, 6'Lİ		924	4																														
	601 026 114	DEBİMETRESİZ KOLEKTÖR SET, 7'Lİ		1.054	4																														
	601 026 115	DEBİMETRESİZ KOLEKTÖR SET, 8'Lİ		1.201	3																														
	601 026 116	DEBİMETRESİZ KOLEKTÖR SET, 9'LU		1.330	3																														
	601 026 117	DEBİMETRESİZ KOLEKTÖR SET, 10'LU		1.479	3																														
	601 026 118	DEBİMETRESİZ KOLEKTÖR SET, 11'Lİ		1.608	2																														
	601 026 119	DEBİMETRESİZ KOLEKTÖR SET, 12'Lİ		1.756	2																														
	601 026 120	DEBİMETRESİZ KOLEKTÖR SET, 13'LÜ	<table border="1"> <thead> <tr> <th>Çıkış Sayısı</th> <th>D</th> <th>d</th> <th>L</th> </tr> </thead> <tbody> <tr><td>2</td><td rowspan="13">G1"</td><td rowspan="13">3/4"</td><td>128,5</td></tr> <tr><td>3</td><td>188,5</td></tr> <tr><td>4</td><td>248,5</td></tr> <tr><td>5</td><td>308,5</td></tr> <tr><td>6</td><td>368,5</td></tr> <tr><td>7</td><td>428,5</td></tr> <tr><td>8</td><td>488,5</td></tr> <tr><td>9</td><td>548,5</td></tr> <tr><td>10</td><td>608,5</td></tr> <tr><td>11</td><td>668,5</td></tr> <tr><td>12</td><td>728,5</td></tr> <tr><td>13</td><td>788,5</td></tr> </tbody> </table>	Çıkış Sayısı	D	d	L	2	G1"	3/4"	128,5	3	188,5	4	248,5	5	308,5	6	368,5	7	428,5	8	488,5	9	548,5	10	608,5	11	668,5	12	728,5	13	788,5	1.904	2
Çıkış Sayısı	D	d	L																																
2	G1"	3/4"	128,5																																
3			188,5																																
4			248,5																																
5			308,5																																
6			368,5																																
7			428,5																																
8			488,5																																
9			548,5																																
10			608,5																																
11			668,5																																
12			728,5																																
13			788,5																																
				<ul style="list-style-type: none"> • Çalışma Basıncı: 6 bar • Test Basıncı: 10 bar (20°C) • Kullanma sıcaklığı: -10°C , +70°C • Gidiş kolektöründe debi ayar klape grupları yoktur. • Dönüş kolektörü aktuatör montajına uygun hat ayar vanalıdır. • Kolektör tapaları dahildir. 																															

DÖŞEMEDEN ISITMA ALYAN ANAHTARLI KOLEKTÖR SETİ

ÜRÜN	ÜRÜN KODU	ÜRÜN ADI	TEKNİK ÇİZİM	LİSTE FİYATI ₺	ÜRÜN KT. AD.
	601 026 214	ALYAN ANAHTARLI KOLEKTÖR SETİ, 2'Lİ		383	12
	601 026 215	ALYAN ANAHTARLI KOLEKTÖR SETİ, 3'LÜ		550	9
	601 026 216	ALYAN ANAHTARLI KOLEKTÖR SETİ, 4'LÜ		716	6
	601 026 217	ALYAN ANAHTARLI KOLEKTÖR SETİ, 5'Lİ		865	4
	601 026 218	ALYAN ANAHTARLI KOLEKTÖR SETİ, 6'LI		1,031	4
	601 026 219	ALYAN ANAHTARLI KOLEKTÖR SETİ, 7'Lİ		1.197	4
	601 026 220	ALYAN ANAHTARLI KOLEKTÖR SETİ, 8'Lİ		1.347	3
	601 026 221	ALYAN ANAHTARLI KOLEKTÖR SETİ, 9'LU		1.514	3
	601 026 222	ALYAN ANAHTARLI KOLEKTÖR SETİ, 10'LU		1.664	3
	601 026 223	ALYAN ANAHTARLI KOLEKTÖR SETİ, 11'Lİ		1.830	2
	601 026 224	ALYAN ANAHTARLI KOLEKTÖR SETİ, 12'Lİ		1.996	2
	601 026 225	ALYAN ANAHTARLI KOLEKTÖR SETİ, 13'LÜ		2.146	2



Çıkış Sayısı	D ₁	D ₂	L
2	G 1"	G 3/4"	128,5
3			188,5
4			248,5
5			308,5
6			368,5
7			428,5
8			488,5
9			548,5
10			608,5
11			668,5
12			728,5
13			788,5

- Çalışma Basıncı: 6 bar
- Test Basıncı: 10 bar (20°C)
- Kullanma sıcaklığı: -10°C , +70°C
- Gidiş kolektöründe debi ayar klape grupları yoktur.
- Dönüş kolektörü aktuatör montajına uygun hat ayar vanalıdır.
- Kolektör tapaları dahildir.

TERMAL KONTROL VANA MOTORU (AKTÜATÖR)

ÜRÜN	ÜRÜN KODU	ÜRÜN ADI	TEKNİK ÇİZİM	LİSTE FİYATI ₺	ÜRÜN KT. AD.
	602 120 742	M30X1.5 AKTÜATÖR TERMAL KONTROL VANA MOTORU 230V		140	10



- CE
- Normalde Kapalı(NC). İstenildiğinde Normalde Açık(NO) değişimi yapılabilir.
- Açık ve Kapalı Konum göstergeli.
- Gerilim 230V
- Çevrim süresi:4.5 dakika
- Hareket Mesafesi 3 mm
- İtme kuvveti 90-125N
- Güç 2.5W
- Akım 150mA



2-YOLLU TERMAL KONTROL MOTORLU (AKTÜATÖRLÜ) VANA

ÜRÜN	ÜRÜN KODU	ÜRÜN ADI	TEKNİK ÇİZİM	LİSTE FİYATI ₺	ÜRÜN KT. AD.
	602 120 747	2-YOLLU 1" AKTÜATÖRLÜ VANA - ÇIKIŞ RAKORLU		287	2
	602 120 804	2-YOLLU 1" AKTÜATÖRLÜ VANA DIŞ VİDA x RAKOR BAĞLANTILI		287	2
	602 120 863	2-YOLLU 1" AKTÜATÖRLÜ VANA-GİRİŞ RAKORLU		287	2



- E.C.A. Aktuatör ve E.C.A. Oda Termostatı ile uyumlu çalışır.
- Vana PN16

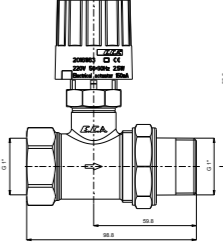

ANA KONTROL ÜNİTESİ

ÜRÜN	ÜRÜN KODU	ÜRÜN ADI	TEKNİK ÇİZİM	LİSTE FİYATI ₺	ÜRÜN KT. AD.
	601 021 010	ANA KONTROL ÜNİTESİ ELEKTRİK SİNYAL DAĞITICI (8 ÇIKIŞLI)		453	3



- CE
- Oda Termostatları, aktuatör, pompa ve karışım valflerinin entegrasyonu/kontrolü.
- Çalışma konum gösterge lambaları
- Elektrik ve Termal emniyetli
- Güç kaynağı: 100-240 VAC 50/60 Hz
- Max. Toplam Akım: 10 A
- Çalışma Sıcaklığı: -20 °C -60°C
- Depolama Sıcaklığı: -20 °C -70 °C

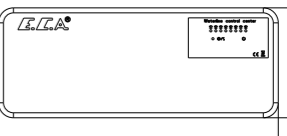

ODA TERMOSTATI

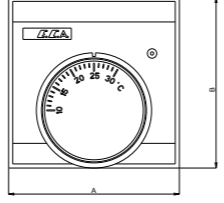
ÜRÜN	ÜRÜN KODU	ÜRÜN ADI	TEKNİK ÇİZİM	LİSTE FİYATI ₺	ÜRÜN KT. AD.												
	601 021 030	MEKANİK ODA TERMOSTATI 10°C-30°C	 <table border="1"> <tr> <td>Kod. No</td> <td>A</td> <td>B</td> </tr> <tr> <td>601 021 030</td> <td>83</td> <td>83</td> </tr> <tr> <td>601 021 033</td> <td>88</td> <td>88</td> </tr> <tr> <td>601 021 031</td> <td>88</td> <td>88</td> </tr> </table>	Kod. No	A	B	601 021 030	83	83	601 021 033	88	88	601 021 031	88	88	115	5
	Kod. No	A		B													
	601 021 030	83		83													
601 021 033	88	88															
601 021 031	88	88															
601 021 033	MEKANİK ODA TERMOSTATI MIN. 15-30°C	115	5														
601 021 031	DİJİTAL ODA TERMOSTATI ANKASTRE-DUVAR İÇİ HAZNELİ • 220/240 V, 50/60Hz	351	5														

AKILLI ODA TERMOSTATI

ÜRÜN	ÜRÜN KODU	ÜRÜN ADI	TEKNİK ÇİZİM	LİSTE FİYATI ₺	ÜRÜN KT. AD.
  	601 021 037	AKILLI ODA TERMOSTATI • Röle Çıkış Tipi: Kuru Kontak • Anahtarlama Kapasitesi: 5A 250VAC / 3A 30VDC • Beslenme Gerilimi: 100-240VAC • Kutu içeriği: Vida Poşeti, Çift taraflı Bant		1.200	3

KOLEKTÖR ASKI SETİ (DÖŞEMEDEN ISITMA)

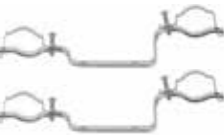
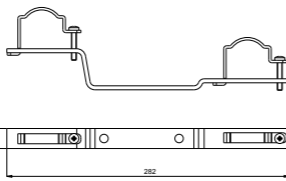
ÜRÜN	ÜRÜN KODU	ÜRÜN ADI	TEKNİK ÇİZİM	LİSTE FİYATI ₺	ÜRÜN KT. AD.
	610 212 003	1" DEBİMETRELİ VE AKTÜATÖR BAĞLANTILI KOLEKTÖRLER İÇİN ASKI SETİ • Duvar sabitleme vidaları hariçtir.		46	10

HAVA/SU BOŞALTMA SETİ

ÜRÜN	ÜRÜN KODU	ÜRÜN ADI	TEKNİK ÇİZİM	LİSTE FİYATI ₺	ÜRÜN KT. AD.
	602 399 746	HAVA/SU BOŞALTMA SETİ KIRMIZI VOLAN		138	10
	602 399 747	HAVA/SU BOŞALTMA SETİ MAVİ VOLAN • Otomatik Havalandırıcı, Mini Küresel Valf, Tee, Redüksiyon Tapa • Max. Çalışma Sıcaklığı: +80°C • Max. Çalışma Basınç: 10 bar		138	10

RAKORLU KÜRESEL VALF

ÜRÜN	ÜRÜN KODU	ÜRÜN ADI	TEKNİK ÇİZİM	LİSTE FİYATI ₺	ÜRÜN KT. AD.
	102 122 205	1" RAKORLU KÜRESEL VALF KIRMIZI KELEBEK VOLANLI		106	15
	102 122 347	1" RAKORLU KÜRESEL VALF MAVİ KELEBEK VOLANLI • PN 10 • Max. Çalışma Sıcaklığı: +80°C • Max. Çalışma Basınç: 10 bar		106	15

TERMOKUPL ÇIKIŞLI RAKORLU KÜRESEL VALF

ÜRÜN	ÜRÜN KODU	ÜRÜN ADI	TEKNİK ÇİZİM	LİSTE FİYATI ₺	ÜRÜN KT. AD.
	602 122 157	1" TERMOKUPL ÇIKIŞLI RAKORLU KÜRESEL VALF • PN 10 • Max. Çalışma Sıcaklığı: +80°C • Max. Çalışma Basınç: 10 bar		111	15

PEX BAĞLANTI RAKOR GRUBU (DÖŞEMEDEN ISITMA)

ÜRÜN	ÜRÜN KODU	ÜRÜN ADI	TEKNİK ÇİZİM	LİSTE FİYATI ₺	ÜRÜN KT. AD.
	602 199 343	1/2" X Ø16X2 MM PEX BAĞLANTI RAKOR GRUBU		22	80
	602 399 929	1/2" X Ø17X2 MM PEX BAĞLANTI RAKOR GRUBU		22	80

YANGIN SİSTEMLERİ









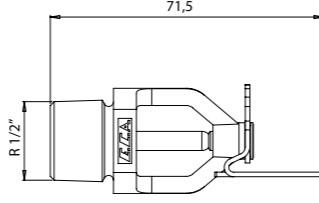

SPRİNKLER

ÜRÜN	ÜRÜN KODU	ÜRÜN ADI	TEKNİK ÇİZİM	LİSTE FİYATI
 	602 112 048 (ST)	Pirinç 68 °C		10,80 \$
	602 112 049 (HT)	Pirinç 68 °C		13,30 \$
	602 112 044 (ST)	Beyaz 68 °C		13,30 \$
	602 112 045 (HT)	Beyaz 68 °C		15,90 \$
	602 112 056 (ST)	Krom 68 °C		12,70 \$
	602 112 057 (HT)	Krom 68 °C		15,30 \$
		<ul style="list-style-type: none"> • K Faktör(1 bar basınçta): K5,6(US) -K80(SI) • 1/2" NPT bağlantılı • Cam Tüp: 5mm(ST) -3mm(HT) 		
 	602 112 050 (ST)	Pirinç 68 °C		19,20 \$
	602 112 051 (HT)	Pirinç 68 °C		20,60 \$
	602 112 052 (ST)	Beyaz 68 °C		21,90 \$
	602 112 053 (HT)	Beyaz 68 °C		23,20 \$
	602 112 058 (ST)	Krom 68 °C		21,10 \$
	602 112 059 (HT)	Krom 68 °C		22,60 \$
		<ul style="list-style-type: none"> • K Faktör(1 bar basınçta): K5,6(US) -K80(SI) • 1/2" NPT bağlantılı • Cam Tüp: 5mm(ST) -3mm(HT) 		
 	602 112 046 (ST)	Pirinç 68 °C		10,80 \$
	602 112 047 (HT)	Pirinç 68 °C		13,30 \$
	602 112 054 (ST)	Krom 68 °C		12,70 \$
	602 112 055 (HT)	Krom 68 °C		15,30 \$
		<ul style="list-style-type: none"> • K Faktör(1 bar basınçta): K5,6(US) -K80(SI) • 1/2" NPT bağlantılı • Cam Tüp: 5mm(ST) -3mm(HT) 		
 	602 112 008 (ST)	Nikel 68 °C		46 t
	602 112 015 (ST)	Nikel - Krom 68 °C		46 t
	602 112 016 (ST)	Beyaz Boyalı 68 °C		55 t
	602 112 023 (ST)	Kumlu 68 °C		44 t
		<ul style="list-style-type: none"> • K Faktör(1 bar basınçta): K5,6(US) -K80(SI) • 1/2" NPT bağlantılı • Cam Tüp: 5mm(ST) -3mm(HT) 		

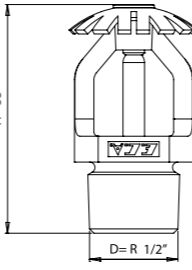

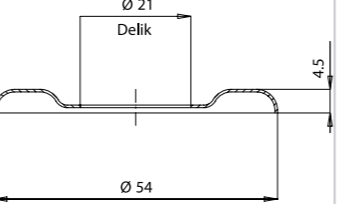

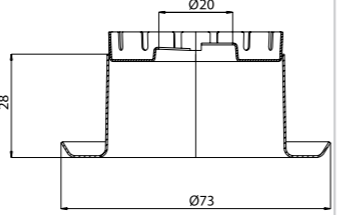

ST: Standart Tepkimeli HT: Hızlı Tepkimeli

SPRİNKLER

ÜRÜN	ÜRÜN KODU	ÜRÜN ADI	TEKNİK ÇİZİM	LİSTE FİYATI
 		DUVAR TİPİ SPRİNKLER (SIDEWALL)		
	602 112 013 (ST)	Nikel 68 °C		55 ₺
	602 112 017 (ST)	Nikel - Krom 68 °C		55 ₺
	602 112 018 (ST)	Beyaz Boyalı 68 °C		63 ₺
602 112 032 (ST)	Kumlu 68 °C	54 ₺		
		<ul style="list-style-type: none"> • K Faktör(1 bar basınçta): K5,6(US) -K80(SI) • 1/2" NPT bağlantılı • Cam Tüp: 5mm(ST) -3mm(HT) 		
 		DİK TİP SPRİNKLER (UPRIGHT)		
	602 112 019 (ST)	Nikel 68 °C		46 ₺
	602 112 020 (ST)	Nikel - Krom 68 °C		46 ₺
	602 112 021 (ST)	Beyaz Boyalı 68 °C		55 ₺
602 112 022 (ST)	Kumlu 68 °C	44 ₺		
		<ul style="list-style-type: none"> • K Faktör(1 bar basınçta): K5,6(US) -K80(SI) • 1/2" NPT bağlantılı • Cam Tüp: 5mm(ST) -3mm(HT) 		
	602 299 965	Nikel		9 ₺
	602 299 966	Beyaz Boyalı		13 ₺
	602 299 967	Nikel		21 ₺
	602 299 968	Beyaz		30 ₺

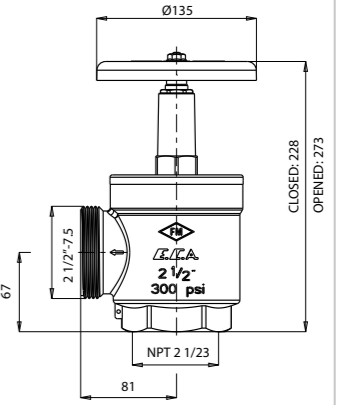

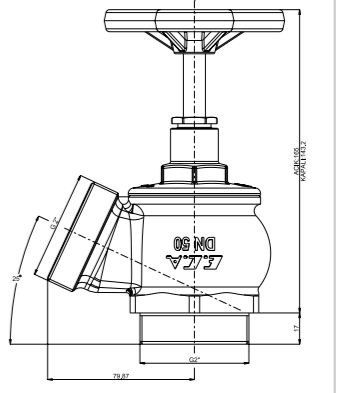
*Farklı sıcaklık değerleri için E.C.A. Üretici-Satış şirketi ile görüşebilirsiniz.

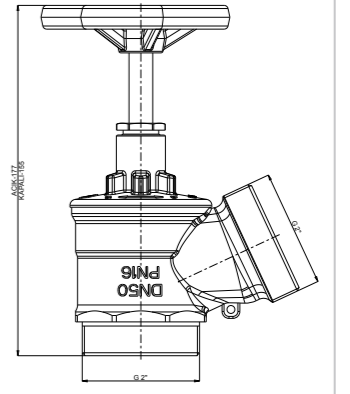
YANGIN VANALARI



ÜRÜN	ÜRÜN KODU	ÜRÜN ADI	TEKNİK ÇİZİM	LİSTE FİYATI
  	601 014 004	İTFAİYE KAT BAĞLANTI VANASI, 2 1/2"		1.507 ₺
		<ul style="list-style-type: none"> • Köşe Tip, • Stop salmastralı, Sınırlayıcısız • Max. çalışma basıncı 300 psi 		
 	601 014 001	YANGIN VANASI, 2"		321 ₺
		<ul style="list-style-type: none"> • TS 12259 • Köşe Tip, • Stop salmastralı, Sınırlayıcısız • PN16 • Çıkış 2" Dış Vida 		
	601 014 002	YANGIN VANASI, 2"		310 ₺
		<ul style="list-style-type: none"> • TS 12259 • Köşe Tip, • Stop salmastralı, Sınırlayıcısız • PN16 • Çıkış 2" Dış Vida 		

• Fiyatlara KDV ayrıca dahil edilir. Tavsiye edilen bayi satış fiyatıdır.
SİRKÜLER NO: S2020101

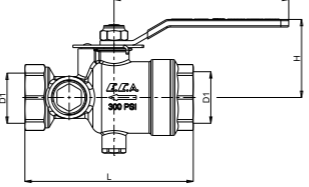
TEST VE DRENAJ VANASI

ÜRÜN	ÜRÜN KODU	ÜRÜN ADI	TEKNİK ÇİZİM	LİSTE FİYATI										
 	601 027 109	TEST DRENAJ VANASI, 1" <ul style="list-style-type: none"> Kapalı, Test, Boşaltma Konumlu K 5,6 Max. çalışma basıncı 300 psi 	 <table border="1"> <thead> <tr> <th>D1</th> <th>D1</th> <th>L</th> <th>H</th> <th>A</th> </tr> </thead> <tbody> <tr> <td>NPT 1 1/4"</td> <td>NPT 1 1/4"</td> <td>133</td> <td>62</td> <td>138</td> </tr> </tbody> </table>	D1	D1	L	H	A	NPT 1 1/4"	NPT 1 1/4"	133	62	138	808 ₺
	D1	D1		L	H	A								
NPT 1 1/4"	NPT 1 1/4"	133	62	138										
601 027 073	TEST DRENAJ VANASI, 1" <ul style="list-style-type: none"> Kapalı, Test, Boşaltma Konumlu Orifis çapı 1/2" Max. çalışma basıncı 300 psi 	817 ₺												

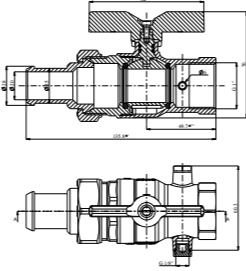
KÜRESEL VALFLER (Hortum Uçlu)

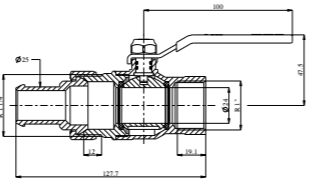
ÜRÜN	ÜRÜN KODU	ÜRÜN ADI	TEKNİK ÇİZİM	LİSTE FİYATI
	602 122 174	KÜRESEL VALF 1' PN16 HORTUM UÇLU MANOMETRE BAĞLANTILI <ul style="list-style-type: none"> PN16 Alüminyum T(kelebek) volan Ø25 Hortum bağlantısı Çift taraflı drenaj imkanı 		212 ₺
	602 122 049	KÜRESEL VALF 1' PN16 HORTUM UÇLU <ul style="list-style-type: none"> PN16 Ø25 Hortum bağlantısı 		181 ₺

NOTLAR:

NOTLAR:

GENEL DAĞITIM

ELMOR TESİSAT MALZEMESİ TİCARET A.Ş.

Merkez

Kemeraltı Cad. Ümmehan No: 17/2 Karaköy/İSTANBUL
Tel: (0212) 705 51 00 Faks: (0 212) 249 90 91
www.eca.com.tr elmor@elmor.com.tr

İstanbul Bölge Satış Müdürlüğü

Kemeraltı Cad. Ümmehan
No: 17/2 Karaköy/İSTANBUL
Tel: (0212) 705 51 00
Faks: (0212) 249 90 91

Ankara Bölge Satış Müdürlüğü

Turan Güneş Bulvarı No:67
Yıldız - Çankaya/ANKARA
Tel: 0850 258 30 20
Faks: (0312) 490 04 45

İzmir Bölge Satış Müdürlüğü

Gaziler Caddesi Yenişehir İş Merkezi
Kat: 1 No: 478/106 Yenişehir/İZMİR
Tel: 0850 258 30 40
Faks: (0232) 469 82 30

Adana Bölge Satış Müdürlüğü

2000 Evler Mahallesi 76066 Sok.
Fonte İş Merkezi A Blok No: 2
Kat: 6 Seyhan/ADANA
Tel: 0850 258 30 00
Faks: (0322) 234 00 76

Antalya Bölge Satış Müdürlüğü

Gebizli Mahallesi Termassos
Bulvarı By Plaza A Blok Kat:4
No: 50/8 Muratpaşa/ANTALYA
Tel: 0850 258 30 60
Faks: (0242) 312 63 20

Bursa Bölge Satış Müdürlüğü

23 Nisan Mahallesi Yunus Emre
Caddesi 255. Sok. Tuğtaş Plaza
No:1 K:4 D:14 Nilüfer/BURSA
Tel: 0850 258 30 50
Faks: (0224) 453 13 70

Trabzon Bölge Satış Müdürlüğü

2 Nolu Beşirli Mahallesi
Devlet Sahil Yolu Cad. 186/7
Ortahisar/TRABZON
Tel: 0850 258 30 70
Faks: (0462) 223 61 22

Konya Bölge Ofisi

Ulaşbaba Caddesi Feritpaşa
Mahallesi Mustafa Kaya İş Merkezi
Tel: (0332) 236 60 68
Faks: (0332) 236 60 52

Samsun Bölge Ofisi

Borkonut Center İş Merkezi
Kiliçdere Mah. Kastamonu Sok.
No:8 / B Kat: 5 / 66
İlkadım/SAMSUN
Tel: (0362) 435 74 30
Faks: (0362) 435 74 34

Diyarbakır Bölge Ofisi

Yılmaz Güney Cad. Ünsa -1
Sitesi B Blok 1/1
Diclekent-Kayapınar/ DİYARBAKIR
Tel: (0412) 257 40 33
Faks: (0412) 257 40 34

Kayseri Bölge Ofisi

İstasyon Cd. Soylu İş Merkezi
Kat:1 No: 8 / KAYSERİ
Tel: (0352) 231 86 18

TEŞHİR ve GALERİLER

İstanbul Elmor Plus

Erenköy Mahallesi Şemsettin
Günaltay Cad. No:207/17-18
Güler Apt. Kadıköy
Tel: (0216) 445 67 93

SATIŞ SONRASI SERVİS



EMAR SATIŞ SONRASI MÜŞTERİ HİZMETLERİ SANAYİ ve TİCARET A.Ş.

Emar Servis Müdürlüğü

İstanbul Bölge Servis Şefliği

Esentepe Mahallesi Kasap Sokak
No:15/1 34394 Şişli/İSTANBUL
Tel: (0212) 370 13 22
Faks: (0212) 370 13 23

Ankara Bölge Servis Şefliği

Turan Güneş Blv. No:67/2
Yıldız -Çankaya / ANKARA
Tel: (0212) 370 13 22
Faks: (0212) 370 13 23

İzmir Bölge Servis Şefliği

1348 Sok. Keremoglu İş Merkezi
No:2/E Yenişehir / İZMİR
Tel: (0212) 370 13 22
Faks: (0212) 370 13 23

Antalya Bölge Servis Şefliği

Gebizli Mah. Termessos Bulvarı
50A/8(302) BY Plaza A Blok
Muratpaşa / ANTALYA
Tel: (0212) 370 13 22
Faks: (0212) 370 13 23

www.emarservis.com.tr

emar@emarservis.com.tr



Y I L L A R C A B E R A B E R

www.eca.com.tr

GENEL DAĞITIM

Elmor Tesisat Malzemesi Ticaret A.Ş.

Tel: (0212) 705 51 00

elmor@elmor.com.tr

YETKİLİ SERVİS

Emar Satış Sonrası Müşteri Hizmetleri San. Tic. A.Ş.

Tel: (0212) 370 13 22

emar@emarservis.com.tr

